

TOSHIBA

Owner's Manual

Integrated High Definition LCD Television

COLORSTREAM[®] HD  DOLBY
DIGITAL

HDMI  HDTV
HIGH DEFINITION TELEVISION

19AV500U 19AV501U

For an overview of steps for setting up your new TV, see page 9.

Note: To display a High Definition picture, the TV must be receiving a High Definition signal (such as an over-the-air High Definition TV broadcast, a High Definition digital cable program, or a High Definition digital satellite program). For details, please contact your TV antenna installer, cable provider, or satellite provider.

Owner's Record

The model number and serial number are on the back of your TV. Record these numbers in the spaces below. Refer to these numbers whenever you communicate with your Toshiba dealer about this TV.

Model number:

Serial number:

Dear Customer,

Thank you for purchasing this Toshiba LCD TV. This manual will help you use the many exciting features of your new LCD TV. **Before operating your LCD TV, please read this manual completely**, and keep it nearby for future reference.

Safety Precautions

WARNING: TO REDUCE THE RISK OF FIRE OR ELECTRIC SHOCK, DO NOT EXPOSE THIS APPLIANCE TO RAIN OR MOISTURE.



WARNING: TO REDUCE THE RISK OF ELECTRIC SHOCK, DO NOT REMOVE COVER (OR BACK). NO USER-SERVICEABLE PARTS INSIDE. REFER SERVICING TO QUALIFIED SERVICE PERSONNEL.

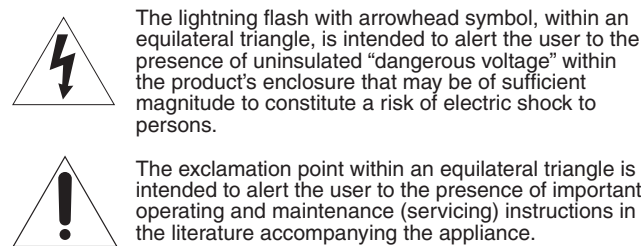

WARNING: If you decide to wall mount this television, always use a UL Listed wall bracket appropriate for the size and weight of this television. For more detail about UL Listed wall bracket, contact a Toshiba Authorized Service Center. The use of any wall bracket other than a UL Listed wall bracket appropriate for the size and weight of this television for wall mounting this television could result in serious bodily injury and/or property damage. See "Removing the Pedestal Stand" (page 5).

NOTE TO CATV INSTALLERS

This is a reminder to call the CATV system installer's attention to Article 820-40 of the U.S. NEC, which provides guidelines for proper grounding and, in particular, specifies that the cable ground shall be connected to the grounding system of the building, as close to the point of cable entry as practical. For additional antenna grounding information, see items 27 and 28 on page 4.

CHILD SAFETY:

It Makes A Difference How and Where You Use Your Flat Panel Display

Congratulations on your purchase! As you enjoy your new product, please keep these safety tips in mind:

The Issue

- The home theater entertainment experience is a growing trend and larger flat panel displays are popular purchases. However, flat panel displays are not always supported on the proper stands or installed according to the manufacturer's recommendations.

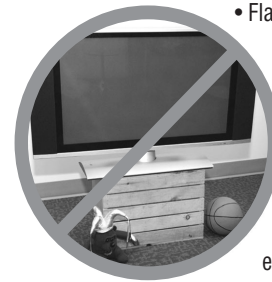

- Flat panel displays that are inappropriately situated on dressers, bookcases, shelves, desks, speakers, chests or carts may fall over and cause injury.

TOSHIBA Cares!

- The consumer electronics industry is committed to making home entertainment enjoyable and safe.

Tune Into Safety

- One size does NOT fit all. Follow the manufacturer's recommendations for the safe installation and use of your flat panel display.
- Carefully read and understand all enclosed instructions for proper use of this product.
- Don't allow children to climb on or play with furniture and television sets.
- Don't place flat panel displays on furniture that can easily be used as steps, such as a chest of drawers.
- Remember that children can become excited while watching a program, especially on a "larger than life" flat panel display. Care should be taken to place or install the display where it cannot be pushed, pulled over, or knocked down.
- Care should be taken to route all cords and cables connected to the flat panel display so that they cannot be pulled or grabbed by curious children.





Wall Mounting: If you decide to wall mount your flat panel display, always:

- Use a mount that has been recommended by the display manufacturer and/or listed by an independent laboratory (such as UL, CSA, ETL).
- Follow all instructions supplied by the display and wall mount manufacturers.
- If you have any doubts about your ability to safely install your flat panel display, contact your retailer about professional installation.
- Make sure that the wall where you are mounting the display is appropriate. Some wall mounts are not designed to be mounted to walls with steel studs or old cinder block construction. If you are unsure, contact a professional installer.
- A minimum of two people are required for installation. Flat panel displays can be heavy.

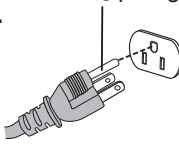
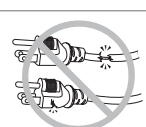

www.CE.org/safety

Important Safety Instructions

- 1) **Read these instructions.**
- 2) **Keep these instructions.**
- 3) **Heed all warnings.**
- 4) **Follow all instructions.**
- 5) **Do not use this apparatus near water.**
- 6) **Clean only with dry cloth.**
- 7) **Do not block any ventilation openings.** Install in accordance with the manufacturer's instructions.
- 8) **Do not install near any heat sources** such as radiators, heat registers, stoves, or other apparatus (including amplifiers) that produce heat.
- 9) **Do not defeat the safety purpose of the polarized or grounding type plug.** A polarized plug has two blades with one wider than the other. A grounding type plug has two blades and a third grounding prong. The wide blade or the third prong are provided for your safety. If the provided plug does not fit into your outlet, consult an electrician for replacement of the obsolete outlet.

- 10) **Protect the power cord** from being walked on or pinched, particularly at plugs, convenience receptacles, and the point where they exit from the apparatus.

- 11) **Only use attachments/accessories specified by the manufacturer.**
- 12) **Use only with the cart, stand, tripod, bracket, or table specified by the manufacturer, or sold with the apparatus.** When a cart is used, use caution when moving the cart/apparatus combination to avoid injury from tip-over.

- 13) **Unplug this apparatus during lightning storms or when unused for long periods of time.**
- 14) **Refer all servicing to qualified service personnel.** Servicing is required when the apparatus has been damaged in any way, such as power-supply cord or plug is damaged, liquid has been spilled or objects have fallen into the apparatus, the apparatus has been exposed to rain or moisture, does not operate normally, or has been dropped.

Additional Safety Precautions

- 14a) **CAUTION:** If the TV is dropped and the cabinet or enclosure surface has been damaged or the TV does not operate normally, take the following precautions:
- ALWAYS turn off the TV and unplug the power cord to avoid possible electric shock or fire.
 - NEVER allow your body to come in contact with any broken glass or liquid from the damaged television. The LCD panel inside the TV contains glass and a toxic liquid. If the liquid comes in contact with your mouth or eyes, or your skin is cut by broken glass, rinse the affected area thoroughly with water and consult your doctor.
 - ALWAYS contact a service technician to inspect the TV any time it has been damaged or dropped.



15) CAUTION:

- To reduce the risk of electric shock, do not use the polarized plug with an extension cord, receptacle, or other outlet unless the blades can be inserted completely to prevent blade exposure.
- To prevent electric shock, match wide blade of plug to wide slot; fully insert.



16) WARNING:

To prevent the spread of fire, keep candles or other open flames away from this product at all times.

Installation, Care, and Service

Installation

Follow these recommendations and precautions and heed all warnings when installing your TV:

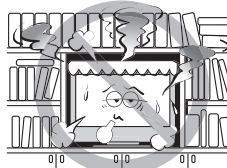
- 17) Never modify this equipment. Changes or modifications may void: a) the warranty, and b) the user's authority to operate this equipment under the rules of the Federal Communications Commission.
- 18) **DANGER: RISK OF SERIOUS PERSONAL INJURY, DEATH, OR EQUIPMENT DAMAGE!** Never place the TV on an unstable cart, stand, or table. The TV may fall, causing serious personal injury, death, or serious damage to the TV.

- 19) To avoid damage to this product, never place or store the TV in direct sunlight; hot, humid areas; or areas subject to excessive dust or vibration.
- 20) Always place the TV on the floor or a sturdy, level, stable surface that can support the weight of the unit.
- 21) The apparatus shall not be exposed to dripping or splashing and that no objects filled with liquids, such as vases, shall be placed on the apparatus.
- 22) Never block or cover the slots or openings in the TV cabinet back, bottom, and sides. Never place the TV:

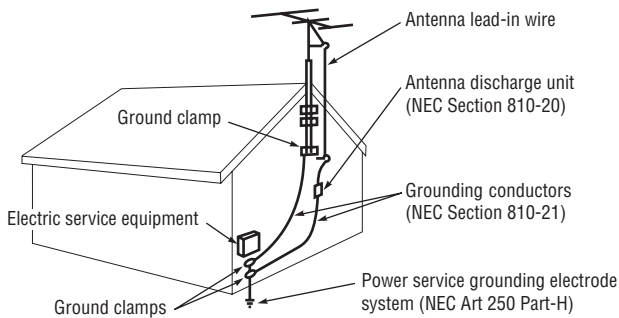
 - on a bed, sofa, rug, or similar surface;
 - too close to drapes, curtains, or walls; or
 - in a confined space such as a bookcase, built-in cabinet, or any other place with poor ventilation.The slots and openings are provided to protect the TV from overheating and to help maintain reliable operation of the TV. Leave a space of at least 4 (four) inches around the TV.
- 23) Always place the back of the television at least four (4) inches away from any vertical surface (such as a wall) to allow proper ventilation.
- 24) Never allow anything to rest on or roll over the power cord, and never place the TV where the power cord is subject to wear or abuse.
- 25) Never overload wall outlets and extension cords.
- 26) Always operate this equipment from a 120 VAC, 60 Hz power source only. *(continued)*

- 27) Always make sure the antenna system is properly grounded to provide adequate protection against voltage surges and built-up static charges (see Section 810 of the National Electric Code).





- 28)  **DANGER: RISK OF SERIOUS PERSONAL INJURY OR DEATH!**
- Use extreme care to make sure you are never in a position where your body (or any item you are in contact with, such as a ladder or screwdriver) can accidentally touch overhead power lines. Never locate the antenna near overhead power lines or other electrical circuits.
 - Never attempt to install any of the following during lightning activity: a) an antenna system; or b) cables, wires, or any home theater component connected to an antenna or phone system.

Care

For better performance and safer operation of your TOSHIBA TV, follow these recommendations and precautions:

- 29) If you use the TV in a room whose temperature is 32 °F (0 °C) or below, the picture brightness may vary until the LCD warms up. This is not a sign of malfunction.
- 30) Always unplug the TV before cleaning. Gently wipe the display panel surface (the TV screen) using a dry, soft cloth only (cotton, flannel, etc.). A hard cloth may damage the surface of the panel. Avoid contact with alcohol, thinner, benzene, acidic or alkaline solvent cleaners, abrasive cleaners, or chemical cloths, which may damage the surface. Never spray volatile compounds such as insecticide on the cabinet. Such products may damage or discolor the cabinet.



- 31)  **WARNING: RISK OF ELECTRIC SHOCK!** 
Never spill liquids or push objects of any kind into the TV cabinet slots.
- 32) While it is thundering, do not touch the connecting cables or apparatus.
- 33) For added protection of your TV from lightning and power surges, always unplug the power cord and disconnect the antenna from the TV if you leave the TV unattended or unused for long periods of time.

- 34) During normal use, the TV may make occasional snapping or popping sounds. This is normal, especially when the unit is being turned on or off. If these sounds become frequent or continuous, unplug the power cord and contact a Toshiba Authorized Service Center.



- 35)  **DANGER: RISK OF SERIOUS PERSONAL INJURY OR DEATH!**



Never strike the screen with a sharp or heavy object.

- 36) • The LCD screen of this product can be damaged by ultraviolet radiation from the sun. When selecting a location for the television, avoid locations where the screen may be exposed to direct sunlight, such as in front of a window.
- Never touch, press, or place anything on the LCD screen. These actions will damage the LCD screen. If you need to clean the LCD screen, follow the instructions in item 30 on this page.

Service

- 37)  **WARNING: RISK OF ELECTRIC SHOCK!** 
Never attempt to service the TV yourself. Opening and removing the covers may expose you to dangerous voltage or other hazards. Failure to follow this WARNING may result in death or serious injury. Refer all servicing not specified in this manual to a Toshiba Authorized Service Center.

- 38) If you have the TV serviced:
- Ask the service technician to use only replacement parts specified by the manufacturer.
 - Upon completion of service, ask the service technician to perform routine safety checks to determine that the TV is in safe operating condition.
- 39) The cold cathode fluorescent lamp in the LCD panel contains a small amount of mercury. When the TV reaches the end of its useful life, dispose of the used TV by the approved method for your area, or ask a qualified service technician to properly dispose of the TV.

 **Note:** The lamp(s) inside this product contain mercury. Disposal may be regulated due to environmental considerations. For disposal or recycling information, contact your local authorities or the Electronics Industries Alliance (www.eiae.org).

Choosing a location for your LCD TV

To Display your LCD TV on the included Pedestal Stand:

Observe the following safety precautions:

- 1) Read and Follow the pedestal assembly instructions.

CAUTION: Before beginning pedestal assembly, carefully lay the front of the LCD Panel face down on a flat, cushioned surface such as a quilt or blanket. Leave the bottom of the unit protruding over the edge of the surface and assemble the pedestal as indicated below.

Note: Extreme care should always be used when attaching the pedestal stand to avoid damage to the LCD panel.

- 2) Place the TV on a sturdy, level surface that can support the weight of the TV.
- 3) Be sure to secure the TV to a wall, pillar, surface, or other immovable structure (page 3).

To Display your LCD TV using a Wall Bracket:

If you decide to wall mount your LCD TV, always use a UL-listed wall bracket appropriate for the size and weight of the LCD TV (see page 2) :

- 1) **CAUTION:** Two people are required for installation.
- 2) Unplug and remove any cables and/or other component connectors from the rear of the TV.
- 3) Remove the screws of the VESA Mounting Pattern show in the right diagram.
- 4) Follow the instructions provided with your wall bracket. Before proceeding, make sure the appropriate bracket(s) are attached to the wall and the back of the TV as described in the instructions provided with the wall bracket.
- 5) After attaching the appropriate bracket(s) to the wall and the back of the TV, remove the pedestal stand from the TV as described below.
- 6) VESA Mounting Pattern

TV Size	Hole Pattern(VxH)	Screw Size
19"	100x100 mm	M4

(unit in mm)

Removing the Pedestal Stand

- 1) Carefully lay the front of the unit face down on a flat, cushioned surface such as a quilt or blanket. Leave the stand protruding over the edge of the surface.

Note: Extreme care should always be used when removing the pedestal stand to avoid damage to the LCD panel.

- 2) Remove the screws shown in the right diagram below. This will allow removal of the pedestal stand.
- 3) Once you have removed all screws holding the pedestal stand in place, remove the pedestal stand from the TV.

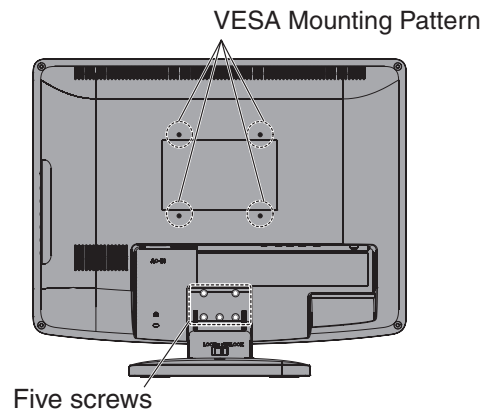

FCC Declaration of Conformity Compliance Statement (Part 15):

The **Toshiba 19AV500U/19AV501U Televisions** comply with Part 15 of the FCC rules.

Operation is subject to the following two conditions: (1) this device may not cause harmful interference, and (2) this device must accept any interference received, including interference that may cause undesired operation.

The party responsible for compliance to these rules is:
Toshiba America Consumer Products, L.L.C.

82 Totowa Rd. Wayne, NJ 07470.

Ph: 1-800-631-3811

Note: *This equipment has been tested and found to comply with the limits for a Class B digital device, pursuant to Part 15 of the FCC rules. These limits are designed to provide reasonable protection against harmful interference in a residential installation. This equipment generates, uses, and can radiate radio frequency energy and, if not installed and used in accordance with the instructions, may cause harmful interference to radio communications. However, there is no guarantee that interference will not occur in a particular installation. If this equipment does cause harmful interference to radio or television reception, which can be determined by removing and applying power to the equipment, the user is encouraged to try to correct the interference by one or more of the following measures:*

- Reorient or relocate the receiving antenna.
- Increase the separation between the equipment and the receiver.
- Connect the equipment into an outlet on a circuit different from that to which the receiver is connected.
- Consult the dealer or an experienced radio/TV technician for help.

Caution: *Changes or modifications to this equipment not expressly approved by Toshiba could void the user's authority to operate this equipment.*

Important notes about your LCD TV

The following symptoms are technical limitations of LCD Display technology and are not an indication of malfunction; therefore, Toshiba is not responsible for perceived issues resulting from these symptoms.

- 1) An afterimage (ghost) may appear on the screen if a fixed, nonmoving image is displayed for a long period of time. The afterimage is not permanent and will disappear in a short period of time.
- 2) The LCD panel contained in this TV is manufactured using an extremely high level of precision technology; however, there may be an occasional pixel (dot of light) that does not operate properly (does not light, remains constantly lit, etc.). This is a structural property of LCD technology, is not a sign of malfunction, and is not covered under your warranty. Such pixels are not visible when the picture is viewed from a normal viewing distance.

Note: *Interactive video games that involve shooting a "gun" type of joystick at an on-screen target may not work with this TV.*

Trademark Information

- Manufactured under license from Dolby Laboratories. Dolby and the double-D symbol are registered trademarks of Dolby Laboratories.
- HDMI, the HDMI logo and High-Definition Multimedia Interface are trademarks or registered trademarks of HDMI Licensing LLC.

Contents

Important Safety Instructions	3
Installation, Care, and Service	3
Chapter 1: Introduction	8
Welcome to Toshiba.....	8
Features of your new TV	8
Overview of steps for installing, setting up, and using your new TV	9
TV front and side panel controls	10
TV back panel connections.....	11
Chapter 2: Connecting your TV	12
Overview of cable types	12
About the connection illustrations.....	12
Connecting a VCR and antenna or Cable TV (no Cable box).....	13
Connecting a VCR with S-video and a cable box	14
Connecting a DVD player with ColorStream® (component video), and a VCR.....	15
Connecting a satellite receiver with ColorStream® (component video).....	16
Connecting a camcorder	16
Connecting an HDMI™ or DVI device to the HDMI input..	17
Connecting a digital audio system.....	18
Connecting a personal computer (PC).....	18
Chapter 3: Using the remote control	20
Preparing the remote control for use	20
Installing the remote control batteries	20
Remote control effective range	20
Learning about the remote control.....	21
Using the remote control to control your other devices	22
Remote Control functional key chart.....	23
Programming the remote control to control your other devices	24
Remote control codes	25
Chapter 4: Menu layout and navigation	27
Main menu layout.....	27
Navigating the menu system.....	28
Chapter 5: Setting up your TV	29
Selecting the menu language	29
Configuring the antenna input source for the ANT/CABLE terminal.....	29
Viewing the digital signal meter.....	29
Viewing the system status.....	29
Programming channels into the TV's channel memory	30
Programming channels automatically.....	30
Manually adding channels in the channel memory.....	30
Manually deleting channels in the channel memory.....	31
Channel memory checking table.....	31
Channel Labels Menu	31
Chapter 6: Using the TV's features	32
Selecting the video input source to view	32
Tuning channel	32
Favorites Browser	32
Tuning to the next programmed channel	32
Tuning to a specific channel (programmed or unprogrammed).....	32
Switching between two channels using Channel Return	32
Selecting the picture size	33
Adjusting the picture	34
Selecting the picture mode.....	34
Adjusting the picture quality.....	35
Using the closed caption mode.....	35
Base closed captions	35
Digital CC Settings	36
Adjusting the audio.....	36
Muting the sound	36
Selecting stereo/SAP broadcasts.....	36
Adjusting the audio quality.....	37
Turning ON/OFF the TV's built in speakers.....	37
Selecting the optical output format	38
Using the Parental Control menu.....	38
Entering the PIN code.....	38
Changing your PIN code.....	39
If you still cannot remember your PIN code.....	39
Blocking TV programs and movies by rating (V-Chip)..	39
Using the PC settings feature.....	40
Setting the PC Audio	41
Setting the sleep timer	41
Setting the time zone	42
Displaying TV status information	42
Understanding the auto power off feature	42
Understanding the last mode memory feature.....	42
Chapter 7: Using the TV's advanced features ...	43
Using the advanced picture settings features.....	43
Using Dynamic Contrast.....	43
Using DynaLight™.....	43
Backlight Adjustment.....	43
Using the static gamma feature.....	44
Using the auto aspect ratio feature.....	44
Selecting the color temperature	45
Using MPEG Noise Reduction	45
Using CableClear® digital noise reduction	45
Chapter 8: Troubleshooting.....	46
General troubleshooting	46
LED indications	47
Chapter 9: Appendix	48
Specifications.....	48
Limited United States Warranty for 19" LCD Televisions.....	50
Limited Canadian Warranty for Toshiba Brand Flat Panel Televisions ...	51

Welcome to Toshiba

Thank you for purchasing this Toshiba LCD TV, one of the most innovative LCD TVs on the market. This digital television is capable of receiving analog basic, digital basic and digital unencrypted cable television programming by direct connection to a cable system providing such programming. Certain advanced and interactive digital cable services such as video-on-demand, a cable operator's enhanced program guide and data-enhanced television services may require the use of a set-top box. For more information call your local cable operator.

Features of your new TV

The following are just a few of the many exciting features of your new Toshiba widescreen, integrated HD, LCD TV:

- **Integrated digital tuning (8VSB ATSC and QAM)**
eliminates the need for a separate digital converter set-top box (in most cases).
- **One HDMI™** digital, high-definition multimedia interfaces 1080i input support (see page 17).
- **HDMI™ (V.1.3 with Lip Sync)**
Lip-Sync allows HDMI source devices to accurately perform synchronization automatically.
- **One set of ColorStream® HD** high-resolution component video inputs (see page 15).
- **Digital Audio Out** optical audio connection with Dolby® Digital optical output format (see page 18).
- **CableClear®** digital picture noise reduction (see page 45).
- **PC IN (Analog RGB)** computer terminal (see page 18).
- **Channel Labels** allows you to put the Call Letters (e.g. ABC, HBO, etc.) on the screen along with the station numbers, so you always know what you're watching (see page 31).

Overview of steps for installing, setting up, and using your new TV

Follow these steps to set up your TV and begin using its many exciting features.

- 1** Carefully read the important safety, installation, care, and service information. Keep this manual for future reference.
- 2** Observe the following when choosing a location for the TV:
 - Read “Important notes about your LCD TV” (☞ page 6).
 - Place the TV on the floor or a sturdy, level, stable surface that can support the weight of the unit. Secure the TV to a wall, pillar, or other immovable structure (☞ page 3).
 - Place the TV in a location where light does not reflect on the screen.
 - Place the TV far enough from walls and other objects to allow proper ventilation. Inadequate ventilation may cause overheating, which will damage the TV. **THIS TYPE OF DAMAGE IS NOT COVERED UNDER THE TOSHIBA WARRANTY.**
- 3** Do not plug in any power cords until **AFTER** you have connected all cables and devices to your TV.
- 4** **BEFORE** connecting cables or devices to the TV, learn the functions of the TV’s connections and controls (☞ pages 10–11).
- 5** Connect your other electronic device(s) to the TV (☞ pages 12–19).
- 6** Install the batteries in the remote control (☞ page 20).
- 7** See “Learning about the remote control” (☞ page 21) for an overview of the buttons on the remote control.
- 8** Program the remote control to operate your other device(s) (☞ pages 22–26).
- 9** **AFTER** connecting all cables and devices, plug in the power cords for your TV and other devices. The LED indication will be red when the TV is on standby mode. The LED indication will be green when press **POWER** on the TV control panel or remote control to turn on the TV.
- 10** See “Menu layout and navigation” for a quick overview of navigating the TV’s menu system (☞ page 27).
- 11** Program channels into the TV’s channel memory (☞ page 30).
- 12** For details on using the TV’s features, see Chapters 6 and 7.
- 13** For help, refer to the Troubleshooting Guide, Chapter 8.
- 14** For technical specifications and warranty information, see Chapter 9.
- 15** Enjoy your new TV!

TV front and side panel controls

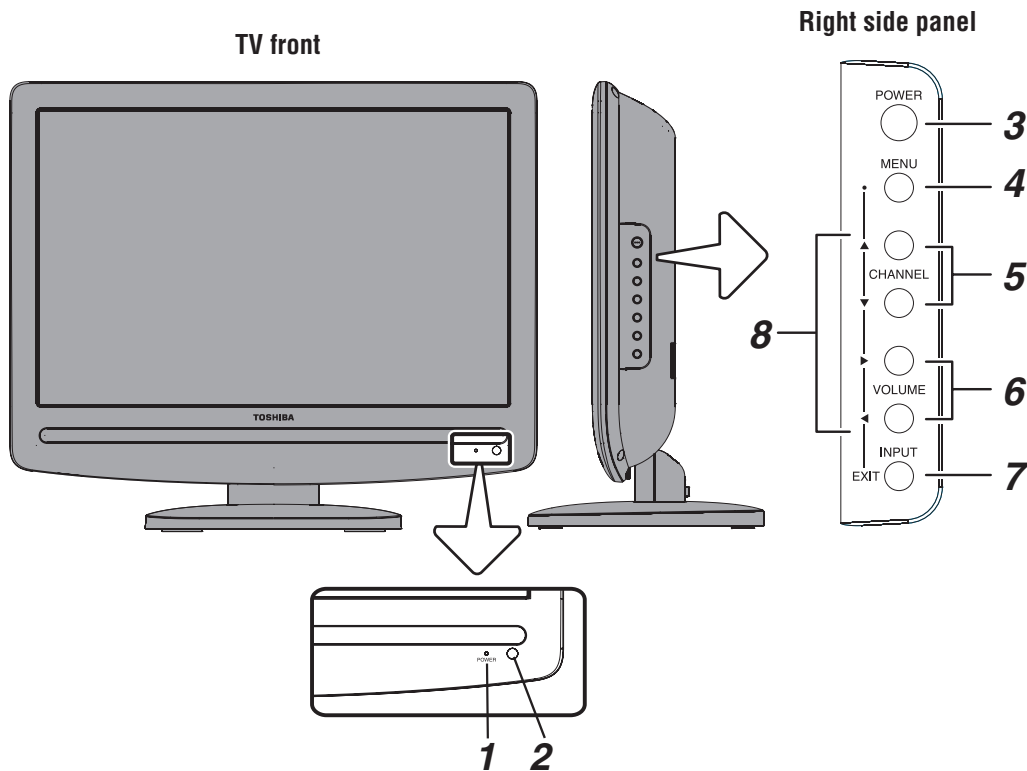

1. Green and Red LEDs

Green = Power On

Red = Power off (standby mode)

See “LED indications” on page 47 for additional information.

2. Remote sensor — Point the remote control toward this remote sensor (see “Remote control effective range” on page 20).

3. POWER — Press to turn the TV on and off.

4. MENU (ENTER) — Press to access the menu system (see pages 27–28). When a menu is on-screen, the **MENU** button on the TV’s control panel functions as the **ENTER** button.

5. CHANNEL ▲▼ — When no menu is on-screen, these buttons change the channel (programmed channels only; see page 30).

6. VOLUME ◀▶ — These buttons adjust the volume level.

7. INPUT — Repeatedly press to change the source you are viewing (**ANT, VIDEO, ColorStream HD, HDMI, PC**).

8. ARROWS ▲▼◀▶ — When a menu is on-screen, these buttons function as up/down/left/right menu navigation buttons.

TV back panel connections

For an explanation of cable types and connections, see pages 12–19.

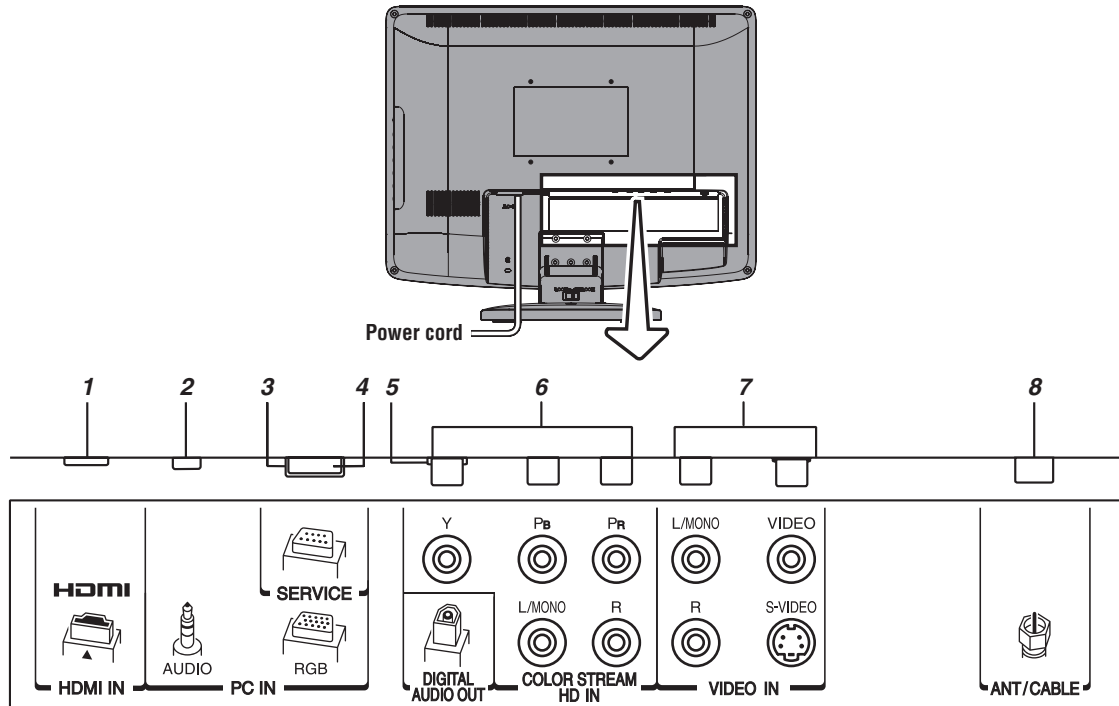

1. **HDMI™ IN** — High-Definition Multimedia Interface input receives digital audio and uncompressed digital video from an HDMI device or uncompressed digital video from a DVI device. Also see item 2. HDMI connection is necessary to receive 1080i signals.
2. **PC IN (AUDIO)**— PC audio input terminals are shared with HDMI analog audio input terminals.
3. **PC IN (RGB)**— For use when connecting a personal computer.
4. **Service** — For service use only. Used for updating the television's firmware.
5. **Digital Audio OUT** — Optical audio output in Dolby Digital or PCM (pulse-code modulation) format for connecting an external Dolby Digital decoder, amplifier, A/V receiver, or home theater system with optical audio input.
6. **ColorStream® HD**— The set of ColorStream® high-definition component video inputs (with standard stereo

audio inputs) for connecting devices with component video output, such as a Toshiba DVD player with ColorStream®.

Note: Component video cables carry only video information; separate audio cables are required for a complete connection.

7. **VIDEO IN** — Standard (composite) video and standard audio inputs plus optional S-video inputs for connecting devices with composite video or S-video output.
Note: Standard (composite) video and S-video cables carry only video information; separate audio cables are required for a complete connection.
8. **ANT/CABLE** — Antenna input that supports analog (NTSC) and digital (ATSC) off-air antenna signals and analog and digital Cable TV (QAM) signals.

HDMI, the HDMI logo and High-Definition Multimedia Interface are trademarks or registered trademarks of HDMI Licensing LLC. Manufactured under license from Dolby Laboratories. Dolby and the double-D symbol are registered trademarks of Dolby Laboratories.

Chapter 2: Connecting your TV

Overview of cable types

Cables can be purchased from most stores that sell audio/video devices. Before purchasing any cables, be sure of connector types required by your devices and the length of each cable.

Coaxial (F-type) cable



Coaxial (F-type) cable is used for connecting your antenna, cable TV service, and/or cable converter box to the **ANT/CABLE** input on your TV.

Standard A/V cables (red/white/yellow)

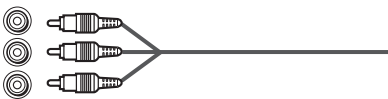

Standard A/V cables (composite video) usually come in sets of three, and are for use with video devices with analog audio and composite video output. These cables (and the related inputs on your TV) are typically color-coded according to use: yellow for video, red for stereo right audio, and white for stereo left (or mono) audio.

S-video cable



S-video cable is for use with video devices with S-video output. Separate audio cables are required for a complete connection.

Note: An S-video cable provides better picture performance than a composite video cable. If you connect an S-video cable, be sure to disconnect the standard (composite) video cable or the picture performance will be unacceptable.

Component video cables (red/green/blue)

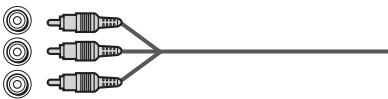

Component video cables come in sets of three and are for use with video devices with component video output. (ColorStream® is Toshiba's brand of component video.) These cables are typically color-coded red, green, and blue. Separate audio cables are required for a complete connection.

Note: Component video cables provide better picture performance than a standard (composite) video or S-video cable.

HDMI™ cable (with HDMI Logo “HDMI”)



HDMI (High-Definition Multimedia Interface) cable is for use with devices with an HDMI output. An HDMI cable delivers digital audio and video in its native format. This cable carries both video and audio information; therefore, separate audio cables are not required for a complete HDMI device connection (see page 17 and page 19).

Note: HDMI cable provides better picture performance than a standard (composite) video or S-video cable.

Optical audio cable



Optical audio cable is for connecting receivers with Dolby Digital or PCM (pulse-code modulation) optical audio input to the TV's **DIGITAL AUDIO OUT** terminal (see page 18).

Analog RGB (15-pin) computer cable

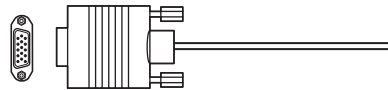

Analog RGB (15-pin) computer cable is for connecting a PC to the TV's **PC IN** terminal (see page 18).

About the connection illustrations

You can connect different types and brands of devices to your TV in several different configurations. The connection illustrations in this manual are representative of typical device connections only. The input/output terminals on your devices may differ from those illustrated herein. For details on connecting and using your specific devices, refer to each device's owner's manual.

Connecting a VCR and antenna or Cable TV (no Cable box)

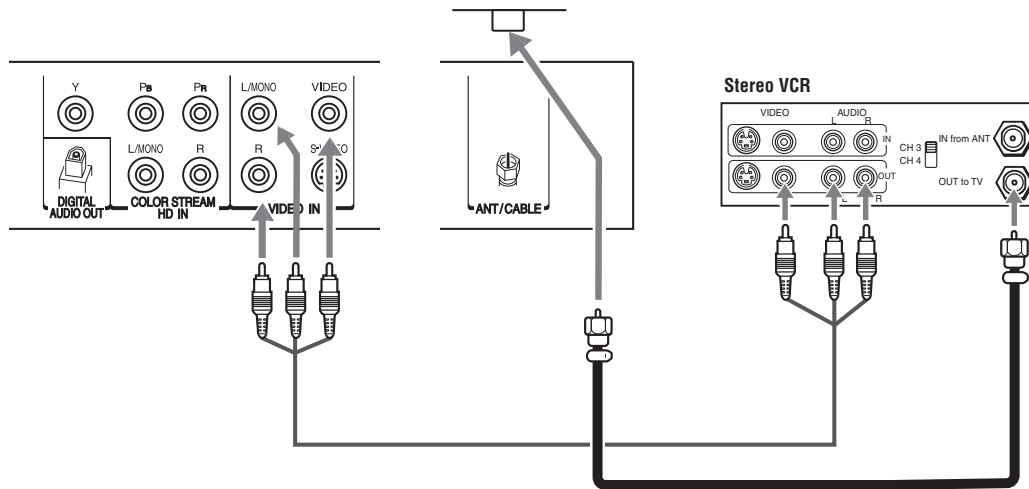

You will need:

- coaxial cables
- standard A/V cables
 - For better picture performance, if your VCR has S-video, use an S-video cable (plus the audio cables) instead of the standard video cable. Do not connect both types of video cable to **VIDEO** at the same time or the picture performance will be unacceptable.
 - If you have a mono VCR, connect **L/MONO** on the TV to your VCR's audio out terminal using the white audio cable only.

To view the antenna or Cable signal:

Select the **ANT** video input source on the TV.*

To view the VCR:

Turn **ON** the VCR. Select the **VIDEO** video input source on the TV.*

* To select the video input source, press **INPUT** on the remote control (see page 21). To program the TV remote control to operate other devices, see Chapter 3.

The unauthorized recording, use, distribution, or revision of television programs, videotapes, DVDs, and other materials is prohibited under the Copyright Laws of the United States and other countries, and may subject you to civil and criminal liability.

Connecting a VCR with S-video and a cable box

An S-video connection will provide better picture performance than a standard (composite) video cable.

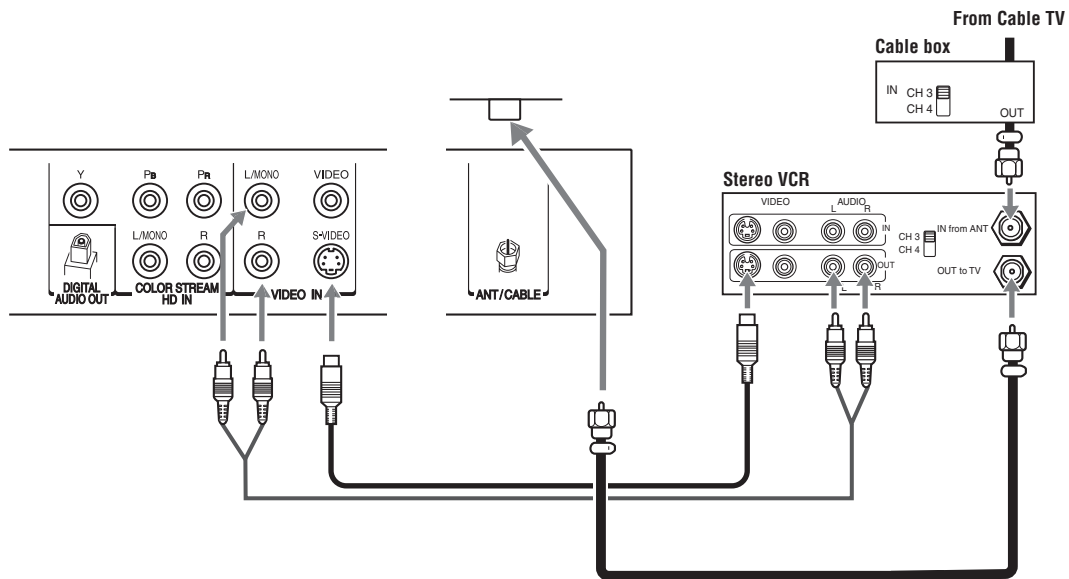

You will need:

- coaxial cables
- S-video cable
 - Do not connect both types of video cable to **VIDEO** at the same time or the picture performance will be unacceptable.
- standard audio cables
 - If you have a mono VCR, connect **L/MONO** on the TV to your VCR's audio out terminal using the white audio cable only.

Note: When you use a Cable box, you may not be able to use the remote control to program or access certain features on the TV.

To view basic and premium Cable channels:

Turn OFF the VCR. Select the **ANT** video input source on the TV.* Tune the TV to channel 3 or 4 (whichever channel the Cable box output is set to). Use the Cable box controls to change channels.

To view the VCR:

Turn ON the VCR. Select the **VIDEO** video input source on the TV.*

* To select the video input source, press **INPUT** on the remote control (see page 21). To program the TV remote control to operate other devices, see Chapter 3.

The unauthorized recording, use, distribution, or revision of television programs, videotapes, DVDs, and other materials is prohibited under the Copyright Laws of the United States and other countries, and may subject you to civil and criminal liability.

Connecting a DVD player with ColorStream® (component video), and a VCR

Your TV has one set of ColorStream® (component video) inputs.

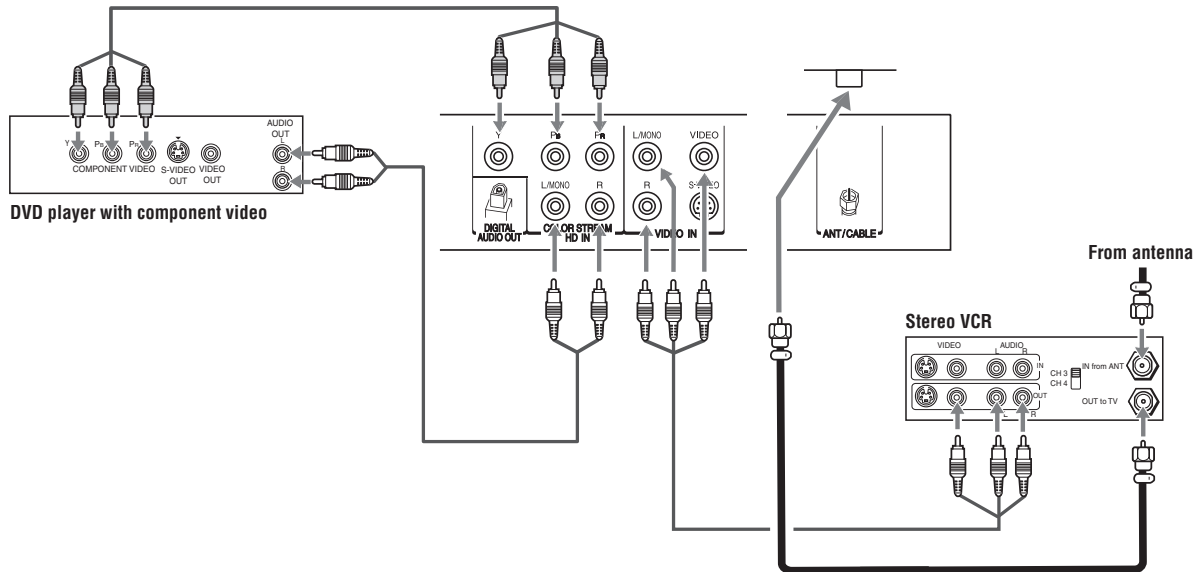

You will need:

- coaxial cables
- standard A/V cables
 - For better picture performance, if your VCR has S-video, use an S-video cable (plus the audio cables) instead of the standard video cable. Do not connect both types of video cable to **VIDEO** at the same time or the picture performance will be unacceptable.
 - If you have a mono VCR, connect **L/MONO** on the TV to your VCR's audio out terminal using the white audio cable only.
- standard audio cables
- component video cables
 - You can connect the component video cables (plus audio cables) from the DVD player to the set of **ColorStream HD** terminal on the TV. The **ColorStream HD** terminal can be used with Progressive (480p, 720p) and Interlaced (480i, 1080i) scan systems. A 1080i signal will provide the best picture performance (1080p is not supported).
 - If your DVD player does not have component video, connect a standard A/V cable to **VIDEO** on the back panel. If your DVD player has HDMI video, see page 17.

To view antenna or Cable channels:

Select the **ANT** video input source on the TV.*

To view the DVD player:

Turn ON the DVD player. Select the **ColorStream HD** video input source on the TV.*

To view the VCR or view and record antenna channels:

Turn ON the VCR. Tune the VCR to the channel you want to watch. Select the **VIDEO** video input source on the TV.*

To record a TV program while watching a DVD:

Turn ON the VCR. Tune the VCR to the channel to record. Select the **ColorStream HD** video input source on the TV* to view the DVD.

* To select the video input source, press **INPUT** on the remote control (see page 21). To program the TV remote control to operate other devices, see Chapter 3.

The unauthorized recording, use, distribution, or revision of television programs, videotapes, DVDs, and other materials is prohibited under the Copyright Laws of the United States and other countries, and may subject you to civil and criminal liability.

Connecting a satellite receiver with ColorStream® (component video)

Your TV has one set of ColorStream® (component video) inputs.

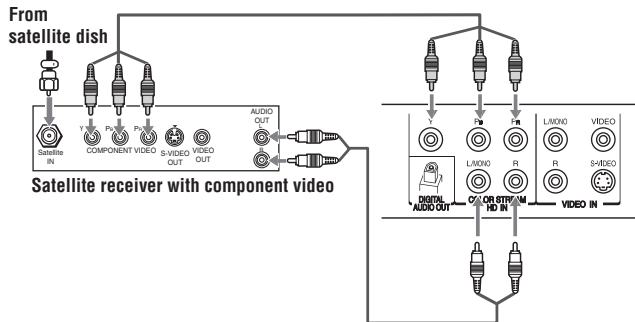

You will need:

- coaxial cables
- standard audio cables
- component video cables
 - You can connect the component video cables (plus audio cables) from the satellite receiver to the set of **ColorStream HD** terminal on the TV. The **ColorStream HD** terminal can be used with Progressive (480p, 720p) and Interlaced (480i, 1080i) scan systems. A 1080i signal will provide the best picture performance (1080p is not supported).
 - If your satellite receiver does not have component video, connect a standard A/V cable to **VIDEO** on the back panel.

To view satellite programs using the component video connections:

Turn on the satellite receiver. Select the **ColorStream HD** video input source on the TV.*

* To select the video input source, press **INPUT** on the remote control (page 21). To program the TV remote control to operate other devices, see Chapter 3.

The unauthorized recording, use, distribution, or revision of television programs, videotapes, DVDs, and other materials is prohibited under the Copyright Laws of the United States and other countries, and may subject you to civil and criminal liability.

Connecting a camcorder

You will need:

- standard A/V cables
 - For better picture performance, if your camcorder has S-video, connect an S-video cable (plus the audio cables) to **VIDEO** on the TV back instead.

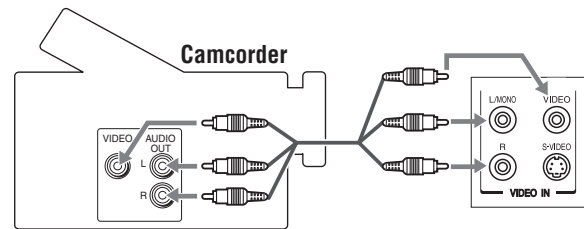

To view the camcorder video:

Select the **VIDEO** video input source on the TV.*

* To select the video input source, press **INPUT** on the remote control (page 21). To program the TV remote control to operate other devices, see Chapter 3.

Connecting an HDMI™ or DVI device to the HDMI input

The HDMI input on your TV receives digital audio and uncompressed digital video from an HDMI source device, or uncompressed digital video from a DVI (Digital Visual Interface) source device. This TV is able to connect with HDMI devices. But it is possible that some HDMI devices may not operate properly with this TV.

This input is designed to accept HDCP (High-Bandwidth Digital-Content Protection) program material in digital form from EIA/CEA-861-D-compliant^[1] consumer electronic devices (such as a set-top box or DVD player with HDMI or DVI output).

The HDMI input can accept and display VGA, SVGA, XGA, 480i (60Hz), 480p (60Hz), 720p (60Hz), and 1080i (60Hz) signal formats. For detailed signal specifications, see page 49. Supported Audio format: Linear PCM, sampling rate 32/44.1/48 kHz

Note: To connect a PC to the HDMI input, see page 19.

To connect an HDMI device, you will need:

- one HDMI cable (type A connector) per HDMI device
 - For proper operation, it is recommended that you use an HDMI cable with the HDMI Logo ().
 - To display an 1080i/60Hz signal format, you will need a Category 2 cable. Conventional HDMI/DVI cable may not work properly.

HDMI cable transfers both video and audio. Separate analog audio cables are not required (see illustration).

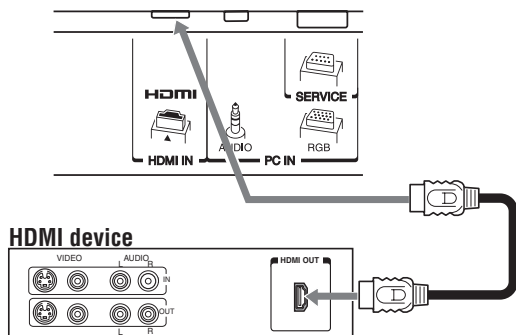

To view the HDMI device video:

Select the HDMI video input source on the TV.*

* To select the video input source, press **INPUT** on the remote control ( page 21). To program the TV remote control to operate other devices, see Chapter 3.

To connect a DVI device, you will need:

- one HDMI-to-DVI adapter cable (HDMI type A connector) per DVI device
 - For proper operation, the length of an HDMI-to-DVI adapter cable should not exceed 9.8 ft (3m). The recommended length is 6.6 ft (2m).
- one pair of standard analog audio cables per DVI device

An HDMI-to-DVI adapter cable transfers video only. Separate analog audio cables are required (see illustration).

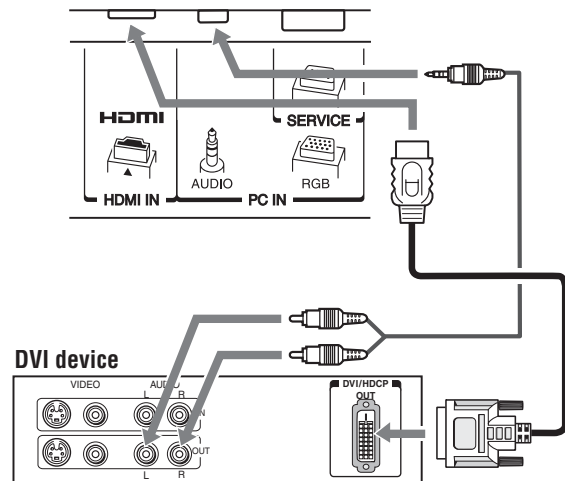

Note: To ensure that the HDMI or DVI device is reset properly, it is recommended that you follow these procedures:

- When turning on your electronic components, **turn on the TV first**, and then the HDMI or DVI device.
- When turning off your electronic components, **turn off the HDMI or DVI device first**, and then the TV.

[1] EIA/CEA-861-D compliance covers the transmission of uncompressed digital video with high-bandwidth digital content protection, which is being standardized for reception of highdefinition video signals. Because this is an evolving technology, it is possible that some devices may not operate properly with the TV.

HDMI, the HDMI logo and High-Definition Multimedia Interface are trademarks or registered trademarks of HDMI Licensing LLC.

Connecting a digital audio system



The TV's **DIGITAL AUDIO OUT** terminal outputs a Dolby®* Digital  or 2-channel down-mixed PCM (pulse-code modulation) signal for use with an external Dolby® Digital decoder or other external audio system with optical audio input.

You will need:

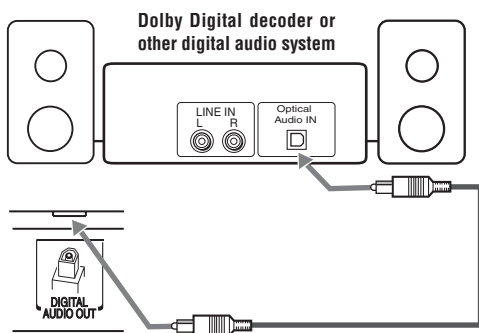
optical audio cable (Use an optical audio cable that has the larger "TosLink" connector and not the smaller "mini-optical" connector.)



To control the audio:

- 1 Turn on the TV and the digital audio device.
- 2 Press  on the TV's remote control and open the **Audio** menu.
- 3 In the **Optical Output Format** field, select either **Dolby Digital** or **PCM**, depending on your device ( "Selecting the optical audio output format" on page 38).

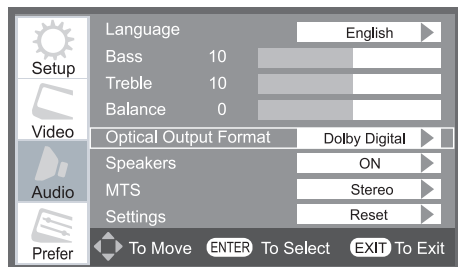

Note:

- Some audio systems may not be compatible with Dolby Digital bitstream signals. Older audio systems that are not compatible with standard optical out signals may not work properly, creating a high noise level that may damage speakers. **THIS DAMAGE IS NOT COVERED BY YOUR WARRANTY.**
- The **DIGITAL AUDIO OUT** terminal may not output some digital audio sources because of copy restrictions.

* Manufactured under license from Dolby Laboratories. Dolby, and the double-D symbol are registered trademarks of Dolby Laboratories.

Connecting a personal computer (PC)

With either the PC IN or HDMI connection, you can watch your computer's display on the TV and hear the sound from the TV's speakers.

To connect a PC to the PC IN terminal on the TV:

When connecting a PC to the PC IN terminal on the TV, use an analog RGB (15-pin) computer cable and a PC audio cable.

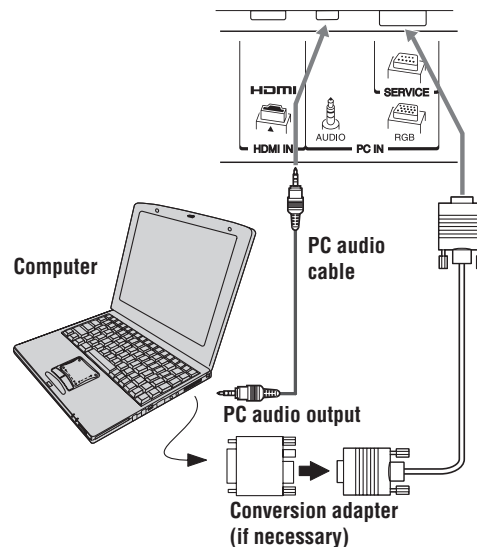

- To use a PC, set the monitor output resolution on the PC before connecting it to the TV. The following signals can be displayed:

Format	Resolution	V. Frequency
VGA	640 × 480	60Hz
SVGA	800 × 600	60Hz
XGA	1024 × 768	60Hz
WXGA	1280 × 768	60Hz
WXGA	1360 × 768	60Hz

Other formats or non-standard signals will not be displayed correctly.

- To display the optimum picture, use the PC setting feature (☞ “Using the PC settings feature” on page 40).

Note:

- The PC audio input terminals on the TV are shared with the HDMI analog audio input terminals (☞ page 41).
- Some PC models cannot be connected to this TV.
- An adapter is not needed for computers with a compatible mini D-sub 15-pin terminal.
- Depending on the DVD's title and the specifications of the PC on which you are playing the DVD-Video, some scenes may be skipped or you may not be able to pause during multi-angle scenes.
- Signal names for mini D-sub 15-pin connector

Pin No.	Signal name	Pin No.	Signal name	Pin No.	Signal name
1	R	6	Ground	11	NC
2	G	7	Ground	12	NC
3	B	8	Ground	13	H-sync
4	NC*	9	NC	14	V-sync
5	NC	10	Ground	15	NC

*NC=Not connected

- If connecting a certain PC model that signal is particular, the PC signal may not be detected correctly.

To connect a PC to the HDMI terminal on the TV:

When connecting a PC to the HDMI terminal on the TV, use an HDMI-to DVI adapter cable and analog audio cables (PC AUDIO IN port just shared with DVI signal from HDMI port only). If connecting a PC with an HDMI terminal, use an HDMI cable (type A connector). Separate analog cables are not necessary (☞ page 17).

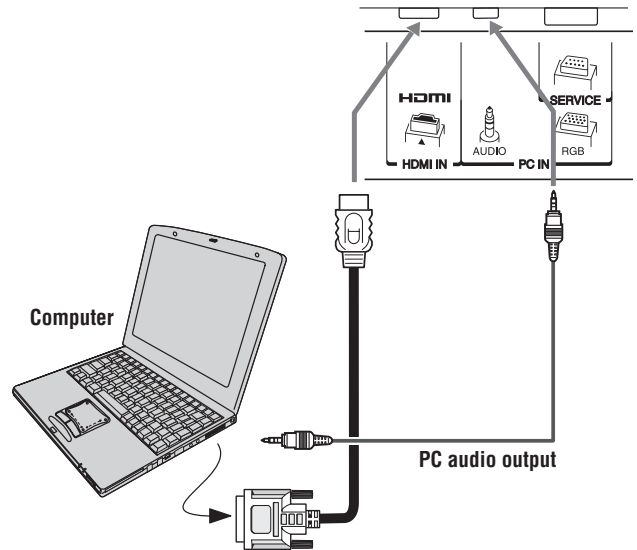

The HDMI input can accept and display VGA, SVGA, XGA, 480i (60Hz), 480p (60Hz), 720p (60Hz), and 1080i (60Hz) signal formats. For detailed signal specifications, see page 49.

Note:

- The edges of the images may be hidden.
- If connecting a certain PC model that signal is particular, the PC signal may not be detected correctly.

Chapter 3: Using the remote control

Preparing the remote control for use

Your TV remote control can operate your TV and many other devices such as cable converter boxes, satellite receivers, VCRs, DVD players, and HTIBs (home theater in a box), even if they are different brands.

If you have a Toshiba device:

Your TV remote control is preprogrammed to operate most Toshiba devices (see page 24).

If you have a non-Toshiba device or a Toshiba device that the remote control is not preprogrammed to operate:

You can program the TV remote control so it will operate the other device (see pages 22–26).

Installing the remote control batteries

- 1 Remove the battery cover from the back of the remote control.

Squeeze tab and lift cover.

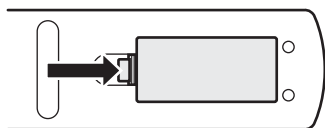

- 2 Install two “AAA” size batteries, making sure to match the + and – signs on the batteries to the signs on the battery compartment.

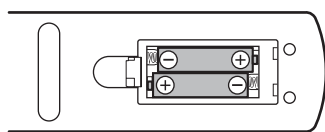

- 3 Reinsert the battery cover in the remote control until the tab snaps.

Caution:

- Dispose of batteries in a designated disposal area. Never throw batteries into a fire.
- Attention should be drawn to the environmental aspects of battery disposal.
- Never mix battery types or combine used batteries with new ones.
- Batteries shall not be exposed to excessive heat such as sunshine, fire or the like.

Note:

- Be sure to use AAA size batteries.
- Dispose of batteries in a designated disposal area.
- Batteries should always be disposed of with the environment in mind. Always dispose of batteries in accordance with applicable laws and regulations.

- If the remote control does not operate correctly, or if the operating range becomes reduced, replace batteries with new ones.
- When necessary to replace batteries in the remote control, always replace both batteries with new ones. Never mix battery types or use new and used batteries in combination.
- Always remove batteries from the remote control if they are dead or if the remote control is not to be used for an extended period of time. This will prevent battery acid from leaking into the battery compartment.

Remote control effective range

For optimum performance, aim the remote control directly at the TV and make sure there is no obstruction between the remote control and the TV.

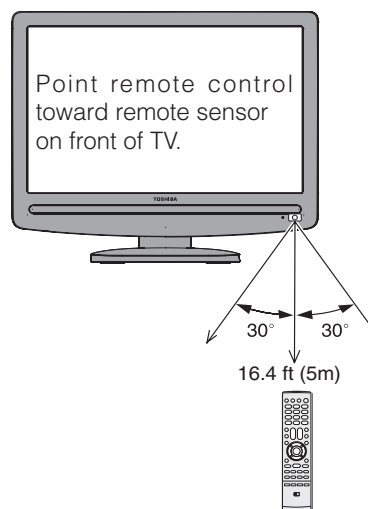

Learning about the remote control

The buttons used for operating the TV only are described here. For a complete list of the remote control's functions, see the remote control functional key chart (page 23).

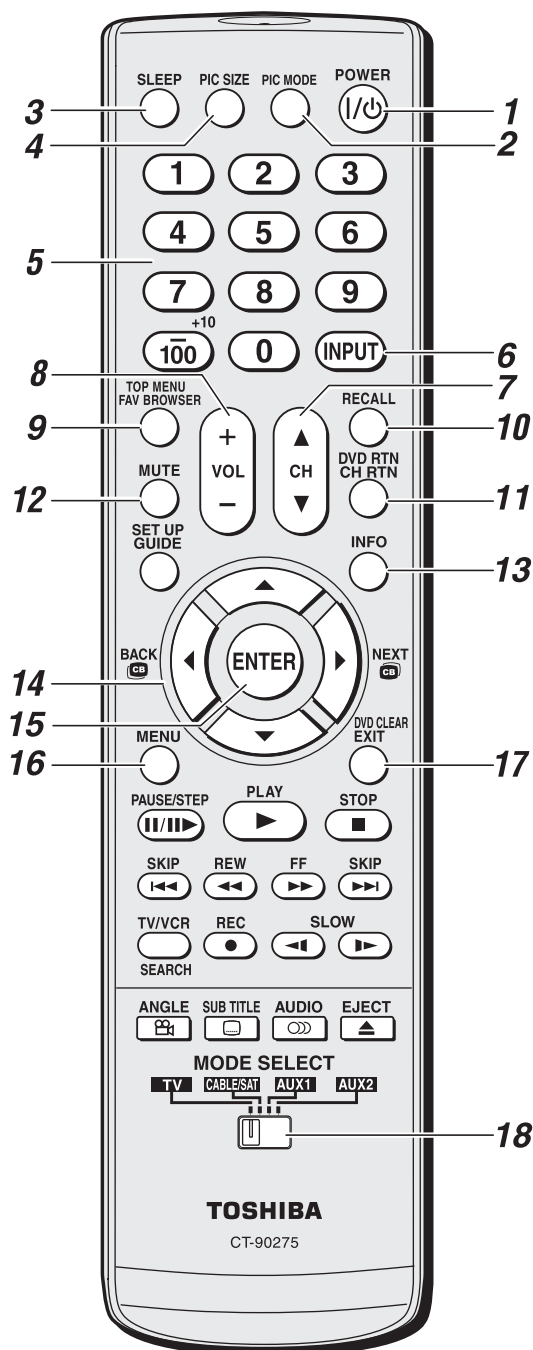

1. **POWER** turns the TV on and off. When the TV is on, the green LED indicator on the TV front will be illuminated.
2. **PIC MODE** selects the picture mode (page 34).
3. **SLEEP** accesses the sleep timer (page 41).
4. **PIC SIZE** cycles through the picture sizes: **Full**, **TheaterWide 1/2/3**, **Natural** (page 33).
5. **Channel Numbers (0–9, –/100)** directly tune channels. The **100** button is used to tune digital channels (page 32) or to be the numeric key for other function.
6. **INPUT** selects the video input source (page 32).
7. **CH ▲▼** cycles through programmed channels (page 30).
8. **VOL + –** adjusts the volume level.
9. **FAV BROWSER** accesses the favorites list in the Favorites Channel Set Menu (page 32).
10. **RECALL** displays TV status information (page 42).
11. **CH RTN** returns to the last viewed channel (page 32).
12. **MUTE** reduces or turns off the sound (page 36).
13. **INFO** displays TV status information as well as program details, when available (page 42).
14. **Arrow buttons (▲▼◀▶)** When a menu is on-screen, these buttons select or adjust programming menus.
15. **ENTER** activates highlighted items in the main menu system.
16. **MENU** accesses the main TV menu system (page 27).
17. **EXIT** closes on-screen menus.
18. **MODE SELECT switch** switches between TV, CABLE/SAT, AUX 1, and AUX 2 modes (page 22). Set to “TV” to control the TV.

Note: The error message “NOT AVAILABLE” may appear if you press a key for a function that is not available.

Using the remote control to control your other devices

If you have a non-Toshiba device or a Toshiba device that the remote control is not preprogrammed to operate, you must first program the remote control to recognize the device (if you have not already done so) (see pages 24–26).

To use your TV remote control to operate a:

- Cable converter box or satellite receiver, set the **MODE SELECT switch** to **CABLE/SAT**.
- VCR, set the **MODE SELECT switch** to **AUX 1**.
- DVD player or HTIB, set the **MODE SELECT switch** to **AUX 2**.

Note: Even after the TV remote control is programmed, it may not operate certain features on any other devices. If this happens and you wish to use those features, you will need to use the device's original remote control.

Point the remote control directly at the device.

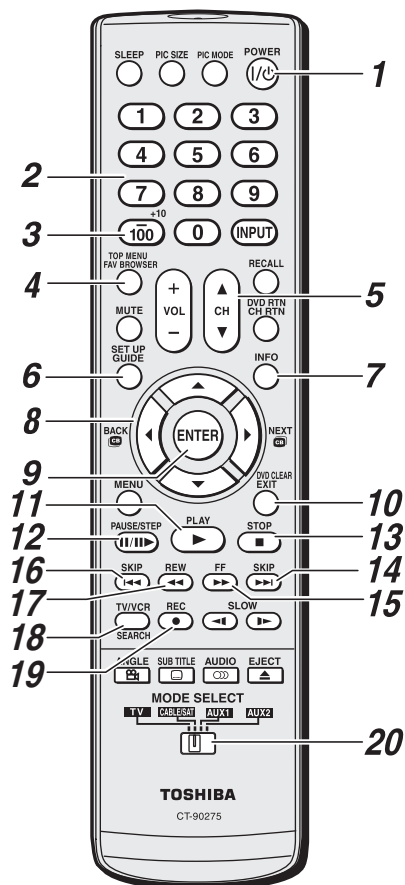



1. **POWER** Turns the selected device on and off.
2. **Channel Numbers (0-9)** Press to directly access channels (as opposed to $\left[\text{CH} \right] \left[\text{CH} \right]$) or to be the numeric key for other function.
3. **+10** Press to directly access DVD chapters higher than 10.
4. **TOP MENU** Accesses a DVD's top menu.
5. **CH ▲▼** For channels programmed into the channel memory (see page 30):
▲ selects the next higher channel.
▼ selects the next lower channel.
6. **GUIDE** Displays the channel guide in the CABLE/SAT mode.
SET UP Accesses a DVD's setup menu in the AUX mode.
7. **INFO** Displays TV status information on-screen.
8. **▲▼◀▶** Press to navigate DVD menus (may not work on some DVD players).
9. **ENTER** Required by some satellite receivers and DVD players to activate certain functions.
10. **DVD CLEAR** Press to reset the title and chapter number.
11. **PLAY** Begins playback of a tape or DVD.
12. **PAUSE** Press during play or record mode to pause the picture; press again to restart.
13. **STOP** Stops the tape or DVD.
14. **SKIP ▶▶** Skips forward to locate later DVD chapters.
15. **FF** Fast-forwards the tape or DVD. (Press during play mode to view the picture moving rapidly forward.)
16. **SKIP ◀◀** Skips back to beginning of current DVD chapter, or locates previous chapters.
17. **REW** Rewinds/reverses the tape or DVD. (Press during play mode to view the picture moving rapidly backward.)
18. **TV/VCR** To view one program while recording another, press to select TV mode.
SEARCH selects a specific DVD chapter, title or time.
19. **REC** Starts tape recording.
20. **MODE SELECT switch** Set to "TV" to control the TV; "CABLE/SAT" to control a cable converter box or satellite receiver; "AUX 1" to control a VCR; "AUX 2" to control a DVD player or HTIB.

Remote Control functional key chart



Note:

- “---” = key does not send a signal in that remote control mode.
- “←TV” = key will affect the TV, even though the remote control is in another mode.
- * Not available for your TV.

REMOTE CONTROL KEY	Toshiba TV	CABLE	SAT (satellite)	AUX 1 (VCR)	AUX 2 (DVD or HTIB)
POWER	Power	Power	Power	Power	Power
SLEEP	Sleep timer	← TV	← TV	← TV	← TV
PIC SIZE	Picture size	← TV	← TV	← TV	← TV
PIC MODE	PIC MODE	← TV	← TV	← TV	← TV
1-9	Digit 1-9	Digit 1-9	Digit 1-9	Digit 1-9	Digit 1-9
0	Digit 0	Digit 0	Digit 0	Digit 0	Digit 0
100/-/+10	- (sub CH)	---	- (sub CH)	100	+10
INPUT	TV/Video select	← TV	← TV	← TV	← TV
FAV BROWSER/ TOP MENU	FAV BROWSER DVD TOP Menu*	---	---	---	Top Menu
MUTE	Sound mute	← TV	← TV	← TV	← TV
SET UP/GUIDE	Guide*	---	SAT Guide	---	Setup
VOL + -	Volume up/down	← TV	← TV	← TV	← TV
CH▲▼	Channel up/down	Channel up/down	Channel up/down	Channel up/down	---
RECALL	RECALL	← TV	← TV	← TV	← TV
CH RTN/DVD RTN	Previous channel DVD previous menu*	---	---	---	DVD Return
INFO	Info	---	Info	---	Display
ENTER	Enter	---	Select, Enter	---	Enter
▲▼	Menu up/down	---	Menu up/down	---	Menu up/down
	Menu left/ Channel Browser™ *	---	Menu left	---	Menu left
	Menu right/ Channel Browser™ *	---	Menu right	---	Menu right
MENU	Menu	---	Action Menu	---	DVD Menu
EXIT/DVD CLEAR	Exit DVD clear*	---	Exit	---	DVD Clear
PAUSE/STEP	Pause*	---	---	Pause	Pause
PLAY	Play*	---	---	Play	Play
STOP	Stop*	---	---	Stop	Stop
SKIP ◀◀	Skip REV*	---	---	---	Skip REV
SKIP ▶▶	Skip FWD*	---	---	---	Skip FWD
REW	Rewind*	---	---	Rewind	Rewind
FF	Fast FWD*	---	---	Fast FWD	Fast FWD
TV/VCR/ SEARCH	DVD search*	---	---	TV/VCR	DVD search
REC	REC MENU*	---	---	Record (2 click)	---
SLOW -	SLOW REW*	---	---	---	---
SLOW +	SLOW FWD*	---	---	---	---
ANGLE	Angle*	---	---	---	DVD Angle
SUB TITLE	Sub title*	---	---	---	DVD Sub title
AUDIO	Audio*	---	---	---	DVD Audio
EJECT	Eject*	---	---	---	DVD Eject

Programming the remote control to control your other devices

Your Toshiba TV remote control is preprogrammed to operate most Toshiba devices. To program your TV remote control to operate a non-Toshiba device (or a Toshiba device that it is not preprogrammed to operate), follow the steps below. For details on using the remote control to operate the device, see page 22.

- 1 In the remote control code table (see page 25), find the code for your device. If more than one code is listed, try each one separately until you find one that works.
- 2 Set the **MODE SELECT switch** to the type of device you are programming the remote control to operate — CABLE/SAT (for a cable converter box or satellite receiver), AUX 1 (for a VCR or TV/VCR combo), or AUX 2 (for a DVD player or HTIB [home theater in a box]).
- 3 While holding down , press the Channel Number buttons to enter the 3-digit code for your device.
- 4 To test the code, turn on the device, point the remote control at it, and press . See notes below.
 - If the correct code was entered, the device will turn off.
 - If the device does not respond, repeat steps 1–4 using another code.
 - If the device does not respond to another code, you will need to use the remote control that came with the device.
- 5 Remember to set the **MODE SELECT switch** back to “TV” to control the TV.
- 6 For future reference, write down the code(s) you used:

DEVICE	CODE	DEVICE	CODE

Note:

- In addition to POWER, confirm that all necessary keys on the TV remote control operate your device. If some keys are not operational, repeat the device code setup using another code (if other codes are listed for your device). If, after trying all listed codes, the necessary keys do not operate your device, use the device's original remote control.
- Every time you change the batteries, you will need to reprogram the remote control.
- Some newer VCRs respond to either of two codes. These VCRs have a switch labeled “VCR1/VCR2.” If your VCR has this kind of switch and does not respond to the codes for your VCR brand, set the switch to the other position (“VCR1” or “VCR2”) and reprogram the remote control.

Remote control codes

In some cases you may not be able to operate your device with the TV remote control. Your other device may use a code that is not recognized by the TV remote control. If this happens, use the device's remote control.

Cable converter box

ABC	061, 062, 063, 082, 084, 087, 092, 096, 098
Archer	065, 092, 097, 099
Cableview	064, 094
Century	092
Citizen	090, 092, 097
Contec	083, 085, 086, 088, 093, 098
Diamond	093
GE	061, 062
Gemini	069, 070, 094
Hamlin	093
Hitachi	062, 095, 096
Jasco	097
Motorola/GI/Jerrold	062, 069, 071, 082, 086, 089, 096, 107, 072, 096
Magnavox	092, 104
Memorex	090
Multi Canal	101
Novavision	081, 083, 085
Panasonic	087
Philco	066, 067, 068, 070, 072, 073, 074, 075, 092
Philips	076, 077
Pioneer	061, 062
Proscan	092, 097, 099
Radio Shack	064, 081
RCA	065
Realistic	102
Recoton	077, 090
Samsung	063, 078, 079, 080, 088, 098, 101, 105
Scientific Atlanta	095
Sears	062
Signature	096
Signature 2000	081, 085
Sprucer	069, 082, 087, 096, 103, 104
Starcom	069, 090
Stargate	095, 100
Sylvania	090
Sylvania	100
TeleView	071, 084, 085
Texscan	087, 096, 098
Tocom	082
U. S. Electronics	065, 092, 097, 099, 102, 103
United Cable	096
Universal	
Wards	

Satellite receiver

Alphastar	038, 059
Chaparral	034
DISH Network	057

Drake	020, 040, 044, 046, 050, 053
Echostar	018, 041, 051
Express Vu	057
Fujitsu	027
GE	008, 009, 013
General Instruments	010, 011, 012, 022, 023, 031, 049
Hitachi	033
Hughes	033
Hughes Network Systems	019
Intersat	048
Janeil	027
JVC	017, 057
Kenwood	029
Magnavox	060
Optimus	058
Pansat	036, 052
Primestar	015, 042
Proscan	008, 009, 013
Radio Shack	022, 023, 030
RCA	008, 009, 013, 016
Realistic	030
Samsung	059
Sony	014, 055
Star Choice	057, 106
Star Trak	025, 026, 037, 054
STS	024
Toshiba	000, 001, 002, 003, 004, 005, 006, 007, 020, 031, 056
Uniden	021, 028, 030, 032, 035, 039, 043, 045, 047, 058
Zenith	027

TV/VCR Combo

Action	078
GE	059, 062
Goldstar	065
Panasonic	065
Precision	078
Quasar	065
Realistic	079
Sony	074
Toshiba	057
Zenith	065
Totevision	009, 010, 065

DVD/VCR Combo

Go Video	DVD=087, VCR=081
JVC	DVD=088, VCR=082
RCA	DVD=089, VCR=083
Samsung	DVD=090, VCR=084
Sanyo	DVD=091, VCR=085
Zenith	DVD=092, VCR=086

DVD player

Aiwa	006, 015
Apex	016, 017
BOSE	097
Broksonic	018

Clarion	019
Classic	020
Daewoo	021
Denon	022, 023, 024, 025
Emerson	026, 027
Fisher	028
Funai	027
GE	001, 029, 030
Go Video	087
GPX	031
Hitachi	005, 032, 033, 034, 035
JVC	003, 007, 036, 042, 088
Kenwood	037
Konka	008, 009
Magnavox	004, 038
Memorex	039
Mintek	040
NAD	026
Nakamichi	041
Norcent	043
Onkyo	044
Oritron	058
Panasonic	010, 045, 046, 047, 048, 049, 050
Philips	004, 051
Pioneer	052, 053, 054, 055
Proscan	001, 056
Qwestar	057, 058
RCA	001, 002, 059, 089
Sampo	060
Samsung	061, 062, 086, 090
Sansui	073
Sanyo	063, 091
Sharp	064, 067
Sherwood	074
Sony	011, 012, 065, 066, 068, 069, 070
Sylvania	027
Teac	071
Technics	072
Techwood	075
Toshiba	000, 013, 076, 077, 078
Yamaha	079, 080, 081
Zenith	014, 082, 092

Portable DVD player

Aiwa	093
Audiovox	094, 095
Panasonic	024, 096, 099
RCA	098

VCR

Admiral	049
Aiko	019
Aiwa	018
Akai	003, 004, 037, 038, 039, 058, 069
Audiovox	010
Bell & Howell	007, 068
Broksonic	008, 017
Calix	010
Carver	026
CCE	019
Citizen	009, 010, 011, 012, 013, 014, 015, 019, 057, 073
Colortyme	005

(continued)

Chapter 3: Using the remote control





Craig	009, 010, 016, 061, 065, 079	Orion	054, 057, 062, 065, 068, 072	Video Concepts	005, 006, 011, 012, 039, 053
Curtis Mathes	001, 005, 009, 012, 014, 040, 048, 053, 056, 057	Panasonic	036, 045, 046, 057, 061, 072, 079	Wards	009, 010, 011, 016, 018, 020, 024, 025, 031, 035, 049, 051, 056, 057, 060, 065, 066, 079
Daewoo	011, 013, 015, 017, 018, 019, 057, 078	Pentax	012, 024, 025, 035, 042, 053, 063	White Westinghouse	073
Daytron	078	Pentax Research	014	XR-1000	018
Denon	063	Philco	026, 027, 063	Yamaha	005, 006, 007, 014, 037, 053
Dimensia	001, 048	Philips	026, 031, 044, 057	Zenith	004, 032, 034, 041, 047, 069, 086
Electrohome	010, 020, 065	Pioneer	006, 024, 043, 055		
Emerson	003, 008, 010, 011, 017, 018, 020, 028, 039, 054, 057, 062, 065, 068, 072	Portland	012, 013, 015	HTIB	
Fisher	007, 016, 021, 022, 023, 057, 064, 068, 070, 071, 079	Proscan	001, 002, 048	Lasonic	083
Fuji	004, 041	Proton	061	Panasonic	084
Funai	018, 073	Quasar	045	Venturer	085
Garrard	018	Radio Shack	010, 031, 065		
GE	001, 002, 009, 040, 042, 048, 056	Radio Shack/Realistic	007, 009, 010, 016, 018, 020, 021, 022, 031, 049		
Go Video	056, 059, 061, 081	Radix	010		
Goldstar	005, 010, 014, 054, 056, 065, 067	RCA	001, 002, 003, 009, 024, 025, 029, 035, 040, 042, 045, 048, 055, 056, 063, 071, 083		
Gradiente	018, 065	Realistic	007, 009, 010, 011, 016, 018, 020, 021, 022, 031, 049, 051, 056, 060, 065, 075, 079		
Harman Kardon	005	Ricoh	047		
Hitachi	024, 025, 035, 037, 042, 063, 070, 080	Runco	034		
JBL	076	Samsung	009, 011, 038, 056, 073, 084		
JC Penney	005, 006, 007, 008, 009, 010, 023, 024, 025, 026, 035, 056, 061, 063, 065	Sansui	006, 037, 043, 061		
Jensen	024, 025, 037, 050	Sanyo	007, 009, 016, 054, 064, 068, 071, 075, 079, 085		
JVC	005, 006, 007, 014, 037, 043, 055, 062, 063, 068, 082	Scott	008, 011, 017, 028, 030, 057, 065, 072		
Kenwood	005, 006, 007, 012, 014, 037, 043, 050, 053, 068, 071	Sears	007, 010, 016, 021, 022, 023, 024, 025, 035, 053, 057, 063, 064, 065, 068, 071, 075, 079		
Kodak	010	Sharp	013, 020, 031, 049, 051, 060, 066		
LG	010	Shintom	004, 025, 032, 061		
Lloyds	053, 073, 079	Signature	049		
Logik	061	Signature 2000	075		
LXI	010	Singer	047, 061		
Magnasonic	061, 065, 078	Sony	004, 032, 033, 041, 052, 058, 070, 074, 076, 077, 080		
Magnavox	026, 027, 034, 044, 057, 061, 072	STS	035		
Marantz	005, 006, 007, 012, 014, 026, 053, 067	Sylvania	018, 026, 027, 028, 044, 072		
Memorex	007, 009, 010, 016, 018, 034, 049, 063, 065, 066, 068, 075, 079	Symphonic	018, 050, 051, 053, 073, 079		
MGA	020, 028, 039	Tandy	007		
MGN	056	Tashiko	010		
Minolta	024, 025, 035, 063	Tatung	037		
Mitsubishi	020, 024, 025, 028, 039, 043, 065	Teac	018, 029, 037		
Montgomery Ward	049	Technics	036		
Motorola	049	Teknika	010, 018, 065		
MTC	009, 046, 061	Toshiba	000, 011, 021, 023, 024, 028, 030, 039, 057, 074, 078, 079		
Multitech	009, 012, 018	Totevision	009, 010, 065		
NEC	005, 006, 007, 012, 014, 037, 043, 053, 054, 067, 070	Unitec	073		
Nikko	010	Unitech	009		
Noblex	009	Vector Research	005, 006, 011, 012, 053		
Optimus	010, 049, 065				
Optonica	031				

Chapter 4: Menu layout and navigation

Main menu layout





The tables below and on the next page provide a quick overview of your TV's menu system.

To open the main menus (illustrated below), press  on the remote control or TV control panel.

Icon	Item	Option	Page
 Setup	Input Configuration	→ Antenna / Cable	29
	DTV Signal Meter	→ [Opens the DTV Signal Meter menu]	29
	Auto Ch Search	→ [Opens the Auto Ch Search menu]	30
	Add On Ch Search	→ [Opens the Add On Ch Search]	30
	Manual Ch Set	→ [Set Ch Viewable or Not Viewable]	31
	Channel Labels	→ [Opens the Channel Labels]	31
	Menu Language	→ English / Français / Español	29
	System Status	→ [Opens the System Information menu]	29
 Video	Mode	→ Sports/Standard/Movie/Preference	34
	Contrast	→ 0-100	35
	Brightness	→ 0-100	35
	Color	→ 0-100	35
	Tint	→ -50~+50	35
	Sharpness	→ 0-20	35
	Settings	→ Reset	35
	Advanced Picture	→ [Opens the Advanced Picture menu]	33,43,44,45
 Audio	Language	→ English / Français / Español	37
	Bass	→ 0-20	37
	Treble	→ 0-20	37
	Balance	→ L50~R50	37
	Optical Output Format	→ Dolby Digital / PCM	18,38
	Speakers	→ On / Off	37
	MTS	→ Stereo/ SAP/ Mono	36,37
	Settings	→ Reset	38
 Prefer	Time Zone	→ [Pacific / Alaska / Hawaii / Eastern / Central / Mountain]	42
	Sleep Timer	→ Off / 30 / 60 / 90mins	41
	PC Settings	→ [Opens the PC Settings menu]	40
	Parental Control	→ [Opens the Parental Control menu]	38,39,40
	Digital CC Settings	→ [Opens the Digital CC Settings menu]	36
	Digital CC	→ Off/CS1/CS2/CS3/CS4/CS5/CS6	36
	Analog CC	→ Off/CC1/CC2/CC3/CC4/T1/T2/T3/T4	35,36

* Function items maybe have some difference depend on different video input source.

** (Active = Yes, Inactive = No)

Icon	Item	ANT	Video	ColorStream HD	HDMI	PC	
 Setup	Input Configuration	Yes	No	No	No	No	
	DTV Signal Meter	Yes	No	No	No	No	
	Auto Ch Search	Yes	No	No	No	No	
	Add On Ch Search	Yes	No	No	No	No	
	Manual Ch Set	Yes	No	No	No	No	
	Channel Labels	Yes	No	No	No	No	
	Menu Language	Yes	Yes	Yes	Yes	Yes	
	System Status	Yes	Yes	Yes	Yes	Yes	
 Video	Mode	Yes	Yes	Yes	Yes*	No	
	Contrast	Yes	Yes	Yes	Yes	Yes	
	Brightness	Yes	Yes	Yes	Yes	Yes	
	Color	Yes	Yes	Yes	Yes*	No	
	Tint	Yes	Yes	Yes	Yes*	No	
	Sharpness	Yes	Yes	Yes	Yes*	No	
	Settings	Yes	Yes	Yes	Yes	Yes	
	Advanced Picture	Yes	Yes	Yes	Yes	Yes	
	 Audio	Language	Yes	No	No	No	No
		Bass	Yes	Yes	Yes	Yes	Yes
Treble		Yes	Yes	Yes	Yes	Yes	
Balance		Yes	Yes	Yes	Yes	Yes	
Optical Output Format		Yes	No	No	No	No	
Speakers		Yes	Yes	Yes	Yes	Yes	
MTS		Yes	No	No	No	No	
Settings		Yes	Yes	Yes	Yes	Yes	
 Prefer	Time Zone	Yes	No	No	No	No	
	Sleep Timer	Yes	Yes	Yes	Yes	Yes	
	PC Settings	No	No	No	No	Yes	
	Parental Control	Yes	Yes	No	No	No	
	Digital CC Settings	Yes	No	No	No	No	
	Digital CC	Yes	No	No	No	No	
	Analog CC	Yes	Yes	No	No	No	

* If the HDMI signal is DVI format, the Mode, Color, Tint and Sharpness will be inactive (= No).

Navigating the menu system

You can use the buttons on the remote control or TV control panel to access and navigate your TV's on-screen menu system.

- Press **MENU** to open the menu system.
- When a menu is open, use the up/down/left/right arrow buttons (**▲▼◀▶**) on the remote control or TV control panel to move in the corresponding direction in the menu.
- Press **ENTER** to save your menu settings or select a highlighted item. (A highlighted menu item appears in a different color in the menu.)
- All menus close automatically if you do not make a selection within 60 seconds, except the DTV Signal Meter

menu, which doesn't close automatically.

- To close a menu instantly, press **EXIT**.

Chapter 5: Setting up your TV

Selecting the menu language

You can choose from three different languages (English, French and Spanish) for the on-screen display of menus and messages.

To select the menu language:

- 1 Press **MENU** and open the **Setup** menu.
- 2 Highlight **Menu Language**.
- 3 Press **▶** or **ENTER** to select your preferred menu language.
- 4 Press **EXIT** to close the **Setup** menu.

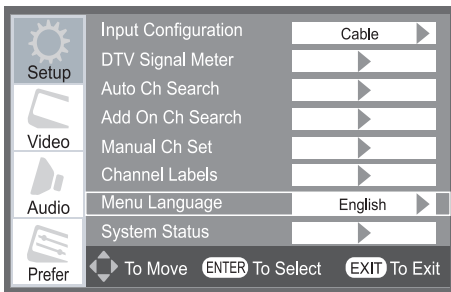

Configuring the antenna input source for the ANT/CABLE terminal

To configure the ANT input source:

- 1 Press **MENU** and open the **Setup** menu.
- 2 Highlight **Input Configuration**.
- 3 Press **▶** or **ENTER** to select the input source (**Cable** or **Antenna**) which input signal connecting to **ANT/CABLE** terminal on the TV.

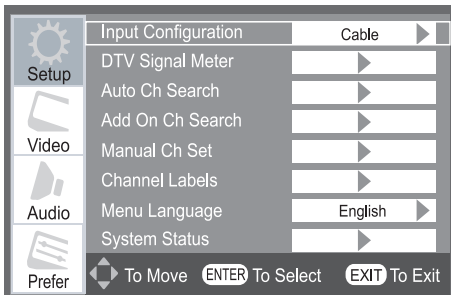

Viewing the digital signal meter

You can view the digital signal meter in the ANT digital TV input source only.

To view the digital signal meter:

- 1 Press **MENU** and open the **Setup** menu.
- 2 Highlight **DTV Signal Meter**.
- 3 Press **▶** or **ENTER**, a new set of **DTV Signal Meter** menu icons will appear as shown below.

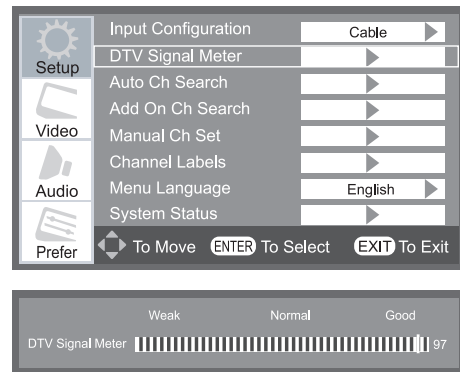

Viewing the system status

To view the system status:

- 1 Press **MENU** and open the **Setup** menu.
- 2 Highlight **System Status**.
- 3 Press **▶** or **ENTER**, the **System Information** menu will appear as below.

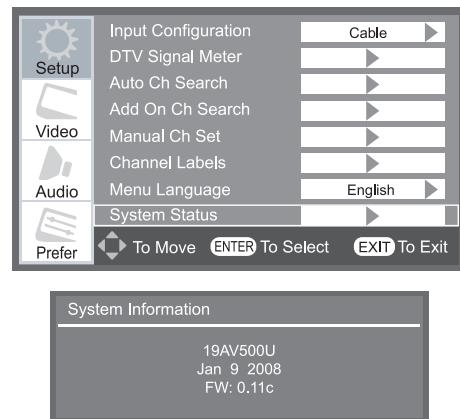

Programming channels into the TV's channel memory

When you press **[CH]** or **[CH]** on the remote control or TV control panel, your TV will stop only on the channels you programmed into the TV's channel memory. Follow the steps below to program channels into the TV's channel memory.

Programming channels automatically

Your TV can automatically detect all active channels in your area and store them in its memory. After the channels are programmed automatically, you can manually add or erase individual channels in the channel memory.

Note:

- You must configure the antenna input source before programming channels (see page 29).
- The automatic channel programming process erases channels that were previously programmed into the TV's memory.
- To tune the TV to a channel not programmed in the channel memory, you must use the Channel Number buttons on the remote control.
- Programming channels when the antenna input is configured for **Cable** will take substantially longer than when the antenna input is configured for **Antenna**. This is normal; however, once channel programming is finished, you should not have to repeat the programming process again unless your Cable TV service lineup changes significantly.

To program channels automatically:

- 1 Configure the antenna input source, if you have not already done so (see page 29).
- 2 Press **MENU** and open the **Setup** menu.
- 3 Highlight **Auto Ch Search**.

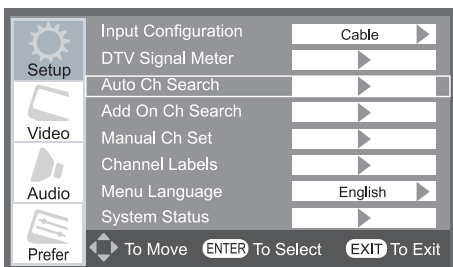

- 4 Press **[CH]** or **[CH]** to begin channel programming (A new set of **Auto Ch Search** menu icons will appear as shown below.)

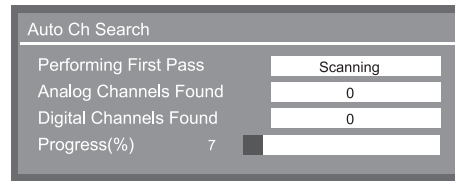

The TV will automatically cycle through all the antenna channels, and store all active channels in the channel memory. While the TV is cycling through the channels, the message "Progress(%)" appears a white bar to indicate the scanning status (as shown above).

- 5 To cancel channel programming, press **EXIT** on the remote control. When channel programming is finished, press **[CH]** or **[CH]** to view the programmed channels.

Manually adding channels in the channel memory

Auto Ch Search can search and save channel information into the channel memory.

There are two ways to add channel information into the channel memory if the program are not exist in Channel memory previously:

(1) To add On Ch Search:

- 1 Press **MENU** and open the **Setup** menu.
- 2 Highlight **Add On Ch Search**.
- 3 Press **[CH]** or **[CH]** to begin channel programming (A new set of Add On Ch Search menu icons will appear as below.)

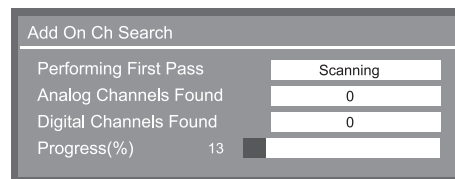

(2) Manually to add channel on a physical channel

For analog Channel:

- 1 Use the Channel Numbers to enter the channel number that you want to add directly. (digital CH may use the Dash **[100]** on the remote control, for example, 56-1)
- 2 Press **[CH]** or **[CH]** on the remote control to save this adding channel to Channel memory.

Manually deleting channels in the channel memory

There is no method really to delete the channel memory except executing Auto Ch Search with a empty RF input. But there is a simple way to disable undesired Channel.

- 1 Press **MENU** and open the **Setup** menu
- 2 Highlight **Manual Ch Set**.

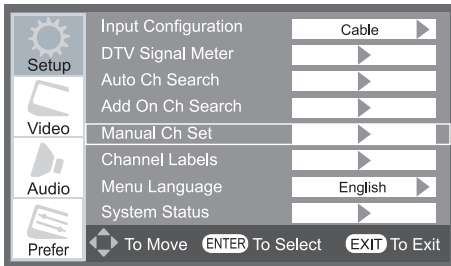

- 3 Press **▶** or **ENTER**, a new set of **Manual Channel Set Menu** will appear as below.

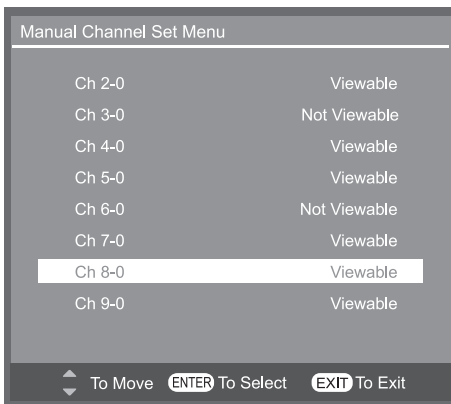

- 4 Press **▲▼** buttons to highlight the channel.
- 5 Press **ENTER** to cycle select Channel is Viewable or Not Viewable.

* If the Channel is marked to "Not Viewable". The channel will be skip when you press "**▲**" or "**▼**", unless you set it to "Viewable" or press Channel Number directly.

Channel memory checking table

All the channel search result can be seen on the Manual Ch Set.

- 1 Press **MENU** and open the **Setup** menu
- 2 Highlight **Manual Ch Set**. and adding or deleting channel memory. Please refer above description.

Channel Labels Menu

A list of common channel labels (logos) for various channels (ABC, CBS, etc.) will be programmed into the TV. You will be able to view and assign these logos from the Channel Labels window. If the desired channel label is not provided in the list, you will be able to manually enter/edit labels using the arrow buttons.

- 1 Press **MENU** and open the **Setup** menu
- 2 Highlight **Channel Labels**.

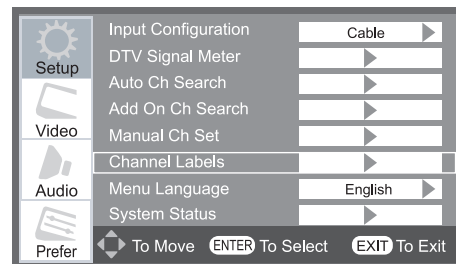

- 3 Press **▶** or **ENTER**, Channel Labels Menu will appear as below.

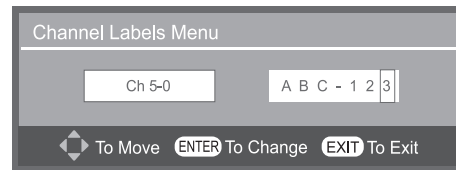

- 4 Left block is original channel No, right block is new channel label. Arrow buttons can edit it (maximum 7 character are available).
- 5 Press **ENTER** to save your setting. And you can see the new Channel Label on top-left of the screen or press **INFO** button on the remote control to show channel information.

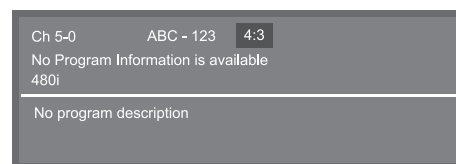
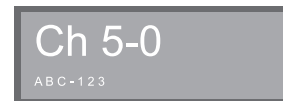

Selecting the video input source to view

To select the video input source to view:

- 1 Press **INPUT** on the remote control or TV control panel.
- 2 And then either:
 - a) Press numeric key 0~4 directly; or
 - b) Repeatedly press **▲▼** on the remote control and then press **ENTER** to change the input; or
 - c) Repeatedly press **INPUT** on the remote control or TV control panel to change the input.

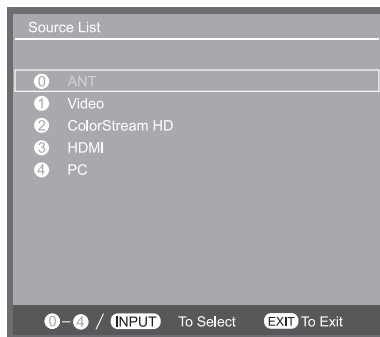

Note:

- “No Signal” will appear randomly on the screen if no signal is received in video input mode.

Tuning channel

Favorites Browser

The Favorites Browser allows you to quickly set up a favorite channels list and let you jump to prefer channel easily (Highlight Channel number then press **ENTER**).

To add a favorite channel:

- 1 Tune to the channel number that you prefer.
- 2 Press **FAV BROWSER** button, a new set of **Favorite Channel Set Menu** will appear as below.



- 3 Press **▶** button to add the current display channel to favorite browser list.

To delete a favorite channel:

- 1 Press **FAV BROWSER** button to open the favorites channel set menu.
- 2 Press **▲▼** buttons to highlight the channel then press **◀** button to delete it.

Tuning to the next programmed channel

To tune to the next programmed channel:

Press **CH** or **CH** on the remote control or TV control panel.

Note: This feature will not work unless you program channels into the TV's channel memory (see page 30).

Tuning to a specific channel (programmed or unprogrammed)

Tuning analog channels:

Press the Channel Number (0–9) on the remote control. For example, to select channel 125, press 1, 2, 5, then **ENTER**.

Tuning digital channels:

Press the Channel Number (0–9) on the remote control, followed by the dash (**100**) button and then the sub-channel number. For example, to select digital channel 125-1, press 1, 2, 5, **-**, 1, then **ENTER**.

Note: If a digital channel is not programmed—either through the automatic channel scan (see page 30) or the channel add/delete function (see page 30)—you will have to tune the RF channel using the Channel Number and dash (**100**) on the remote control.

Switching between two channels using Channel Return

The Channel Return feature allows you to switch between two channels without entering an actual channel number each time.

- 1 Select the first channel you want to view.
- 2 Select a second channel using the Channel Number buttons (and the dash (**100**) button if selecting a digital channel).
- 3 Press **CH RTN** on the remote control. The previous channel will display. Each time you press **CH RTN**, the TV will switch back and forth between the last two channels that were tuned.

Selecting the picture size

You can view many program formats in a variety of picture sizes—**Full**, **TheaterWide 1**, **TheaterWide 2**, **TheaterWide 3** and **Natural**.

Note: The “picture size” illustrations are examples only. The format of the image (in any of the picture sizes) will vary depending on the format of the signal you are currently watching. Select the picture size that displays the current program the way that looks best to you.

You can save separate picture size preferences for each input on your TV.

To select the picture size using the remote control:

Repeatedly press PIC SIZE , picture size will change cyclically as below

Full→TheaterWide 1→ TheaterWide 2→ TheaterWide 3→ Natural→Full

To select the picture size using the menu system:

- 1 Press MENU and open the **Video** menu.
- 2 Highlight **Advanced Picture**.
- 3 Press \blacktriangleright or ENTER , a new set of **Advanced Picture** menu icons will appear as below.
- 4 Press $\blacktriangle/\blacktriangledown$ buttons to highlight **Picture Size**.
- 5 Press \blacktriangleright or ENTER , picture mode is changed cyclically.

Full→TheaterWide 1→ TheaterWide 2→ TheaterWide 3→ Natural→Full

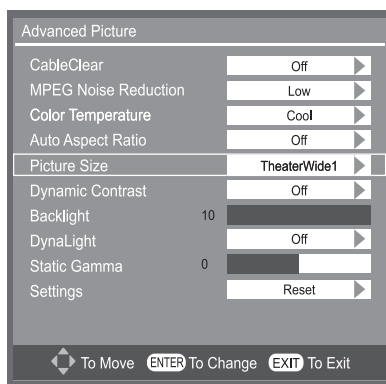

Note: RGB timing only support Natural and Full, no matter the RGB timing is via D-SUB to PC IN or via DVI to HDMI.

Using these functions to change the picture size (i.e., changing the height/ width ratio) for any purpose other than your private viewing may be prohibited under the Copyright Laws of the United States and other countries, and may subject you to civil and criminal liability.

Note: If you select one of the TheaterWide® picture sizes, the top and bottom edges of the picture (including subtitles or captions) may be hidden.

Natural picture size

- The image is displayed close to its originally formatted proportion. Some program formats will display with sidebars and/or bars at the top and bottom.

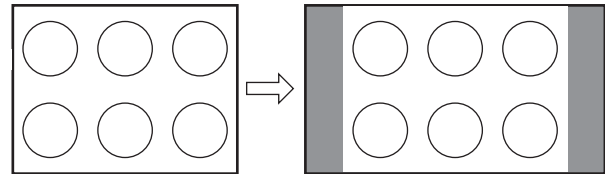

Natural picture size example

TheaterWide 1 picture size (for 4:3 format programs)

- The center of the picture remains close to its original proportion, but the left and right edges are stretched wider to fill the screen.

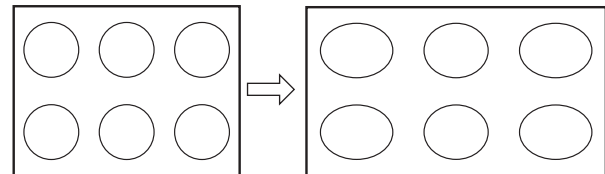

TheaterWide 1 picture size example

TheaterWide 2 picture size (for letter box programs)

- The picture is stretched wider to fill the width of the screen, but only slightly stretched taller.
- The top and bottom edges of the picture may be hidden.

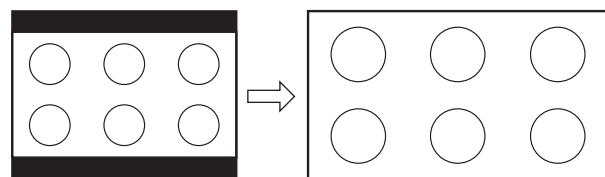

TheaterWide 2 picture size example

TheaterWide 3 picture size (for letter box programs with subtitles)

- The picture is stretched wider to fill the width of the screen, but only slightly stretched taller.

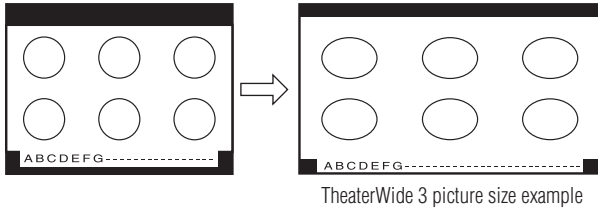

Full picture size

- If receiving a squeezed 4:3 format program, the picture is stretched wider to fill the width of the screen, and slightly stretched taller to fill the entire screen.
- None of the picture is hidden.

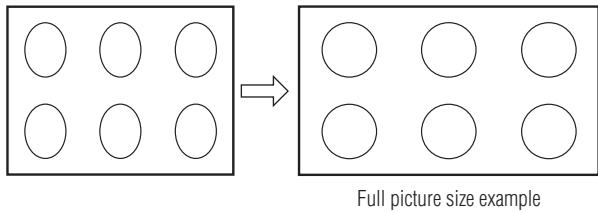

- If receiving a 16:9 format program, the picture is no stretched wider but slightly stretched taller to fill the entire screen.

Adjusting the picture

Selecting the picture mode

You can select your desired picture settings from four different modes, as described below.

Mode	Picture Quality
Sports	Bright and dynamic picture (factory setting)
Standard	Standard picture settings (factory setting)
Movie	Lower contrast for darkened room (factory setting)
Preference	Your personal preferences

To select the picture mode:

Repeatedly press PIC MODE , picture mode will change cyclically as below:

Sports→Standard→Movie→Preference→Sports.

To select the picture mode using the menu system:

- Press MENU and open the **Video** menu.
- Highlight **Mode**.
- Press \blacktriangleright or ENTER , picture mode is changed cyclically.
Sports→Standard→Movie→Preference→Sports

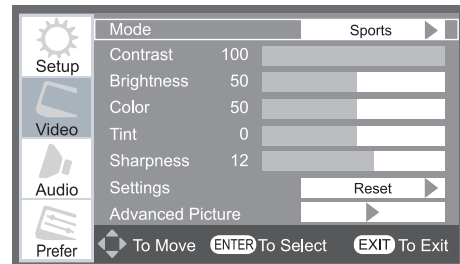

Note: The picture mode you select affects the current input only. You can select a different picture mode for each input.

Adjusting the picture quality

You can adjust the picture quality (Contrast, Brightness, Color, Tint, Sharpness, Dynamic Contrast, Backlight and DynaLight™) to your personal preferences.

Selection	Adjusted Range	Effect
Contrast	0~100	lower~higher
Brightness	0~100	darker~lighter
Color	0~100	paler~deeper
Tint	-50~+50	reddish~greenish
Sharpness	0~20	softer~sharper
Dynamic Contrast	On / Off	N/A
Backlight	0~10	darker~lighter
DynaLight*	On / Off	N/A

* DynaLight™
This function automatically strengthens the black coloring of dark areas in the video according to the level of darkness.

To adjust the picture quality:

- 1 Press **MENU** and open the **Video** menu.
- 2 Highlight each item you want to adjust (**Dynamic Contrast**, **Backlight** and **DynaLight** are under **Advance Picture** item.)
- 3 Press **ENTER**, a new adjustment bar will appear.
- 4 Press **◀** or **▶** to adjust the setting value.
- 5 Press **ENTER** to save and back to previous menu icon, or press **EXIT** to save and quit system menu.

Dynamic Contrast and DynaLight only toggle press **▶** or **ENTER** to set On/Off.

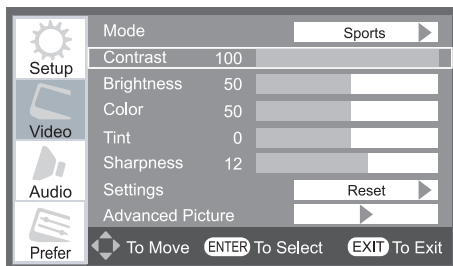

Reset Factory Defaults of Video

To reset all image quality of Video to their factory default values:

- 1 Press **MENU** and open the **Video** menu.
- 2 Highlight **Settings**.
- 3 Press **▶** or **ENTER**, Video settings will recover to factory default values.

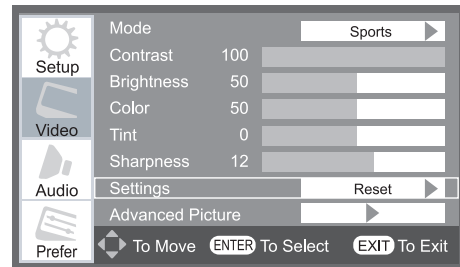

Using the closed caption mode

Base closed captions

The closed caption mode has two options:

- Captions—An on-screen display of the dialogue, narration, and sound effects of TV programs and videos that are closed captioned (usually marked “CC” in program guides).
- Text—An on-screen display of information not related to the current program, such as weather or stock data (when provided by individual stations).

To view Analog captions or text:

- 1 Press **MENU** and open the **Prefer** menu.
- 2 Highlight **Analog CC**.
- 3 Press **▶** or **ENTER** cyclically to select CC type that you want.

Off→CC1→CC2→CC3→CC4→T1→T2→T3→T4→Off

Note: When colorstream input is used, the analog CC setting defaults to Video.

To view captions:

Highlight **CC1**, **CC2**, **CC3**, or **CC4**. (**CC1** displays translation of the primary language in your area.)



Note: If the program or video you selected is not closed captioned, no captions will display on-screen.

- To view text:
Highlight T1, T2, T3, or T4.

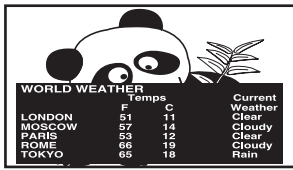

Note: If text is not available in your area, a black rectangle may appear on screen. If this happens, set the Analog CC Mode to OFF.

To view Digital captions:

- Press **MENU** and open the **Prefer** menu.
- Highlight **Digital CC**.
- Press **▶** or **ENTER** cyclically to select CC type that you want.

Off→CS1→CS2→CS3→CS4→CS5→CS6→Off

Note: A Closed caption signal may not display in the following situations:

- This feature is available for digital channels only.
- When a videotape has been dubbed.
- When the signal reception is weak.
- When the signal reception is non-standard.

Digital CC Settings

You can customize the closed caption display characteristics by changing the background color, opacity, text size, type, edge, and color.

Note:

- This feature is available for digital channels only.
- You cannot set the Caption Text and Background as the same color.

To customize the closed captions:

- Press **MENU** and open the **Prefer** menu.
- Highlight **Digital CC Settings**.
- Press **▶** or **ENTER**, a new set of Digital Closed Caption menu icons will appear as below.

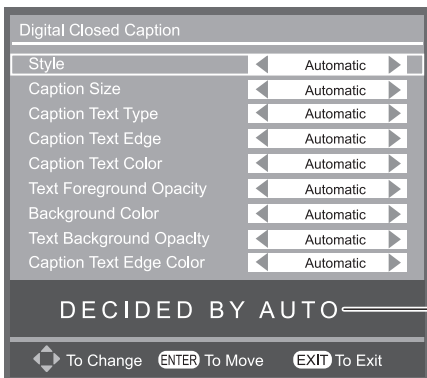

- Style item default setting is Automatic, and you can adjust it by yourself. (Press **◀▶** or **ENTER** to set Style item to Custom)
- Press **▲▼** buttons then press **◀▶** or **ENTER** cyclically to select prefer status (refer below table). And there is a preview area on screen for you reference.

Caption Size	Automatic, Small, Standard, Large
Caption Text Type	Automatic, Default, Mono w. Serif, Prop. w. Serif, Mono w/o Serif, Prop. w/o Serif, Casual, Cursive, Small Capitals
Caption Text Edge	Automatic, None, Raised, Depressed, Uniform, Left Drop Shadow, Right Drop Shadow
Caption Text Color	Automatic, Black, White, Red, Green, Blue, Yellow, Magenta, Cyan
Text Foreground Opacity	Automatic, Transparent, Translucent, Solid, Flashing
Background Color	Automatic, Black, White, Red, Green, Blue, Yellow, Magenta, Cyan
Text Background Opacity	Automatic, Transparent, Translucent, Solid, Flashing
Caption Text Edge Color	Automatic, Black, White, Red, Green, Blue, Yellow, Magenta, Cyan

Adjusting the audio

Muting the sound

Press **MUTE** to partially reduce (1/2 MUTE) or turn off (MUTE) the sound. Each time you press **MUTE**, the mute mode will change in the following order:



Selecting stereo/SAP broadcasts

The multi-channel TV sound (MTS) feature allows you to output high-fidelity stereo sound. MTS also can transmit a second audio program (SAP) containing a second language, music, or other audio information (when provided by individual stations).

When the TV receives a stereo or SAP broadcast, the word "Stereo" or "SAP" appears on-screen when **RECALL** is pressed. The MTS feature is not available when the TV is in VIDEO mode.

To listen to stereo sound:

- 1 Press **MENU** and open the **Audio** menu.
- 2 Highlight **MTS**.
- 3 Press **▶** or **ENTER** to select Stereo, SAP and Mono.

Stereo→SAP→Mono→Stereo

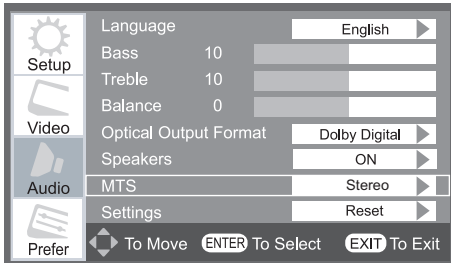

Note:

- You can typically leave the TV in **Stereo** mode because it will automatically output the type of sound being broadcast (stereo or monaural).
- If the stereo sound is noisy, select **Mono** to reduce the noise.

To listen to a second audio program on an analog station (if available):

Select **SAP** in step 3 above.

Note:

- A second audio program (SAP) can be heard only on those TV stations that offer it. For example, a station might broadcast another language as a second audio program. If you have SAP on, you will see the current program on the screen but hear the other language instead of the program's normal audio.
- If you have SAP on and the station you are watching is not broadcasting a second audio program, the station's normal audio will be output. However, occasionally there is no sound at all in **SAP** mode. If this happens, set the **MTS** feature to **Stereo** mode.

To listen to an alternate language on an ATSC digital station (if available):

- 1 Press **MENU** and open the **Audio** menu.
- 2 Highlight **Language**.
- 3 Press **▶** or **ENTER** to select **English, Français** and **Español**.

English→Français→Español→English

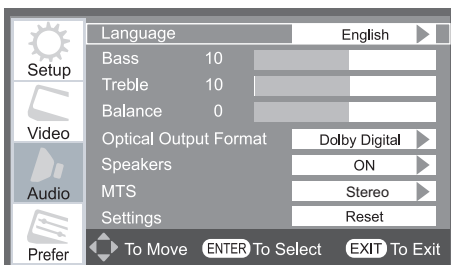

Adjusting the audio quality

You can adjust the audio quality by adjusting the bass, treble, and balance.

To adjust the audio quality:

- 1 Press **MENU** and open the **Audio** menu.
- 2 Highlight the item you want to adjust (**Bass, Treble, or Balance**).
- 3 Press **ENTER**, a new adjustment bar will appear as below.

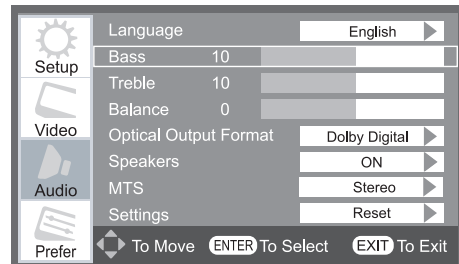

- 4 Press **◀** or **▶** to adjust the level.
 - **◀** makes the bass or treble weaker or increases the balance in the left channel (depending on the item selected).
 - **▶** makes the bass or treble stronger or increases the balance in the right channel (depending on the item selected).
- 5 Press **ENTER** to save and back to previous menu icon, or Press **EXIT** to save and quit system menu.

Turning ON/OFF the TV's built in speakers

- 1 Press **MENU** and open the **Audio** menu.
- 2 Highlight **Speakers**.
- 3 Press **▶** or **ENTER**, to turn ON/OFF the TV's built in speakers.

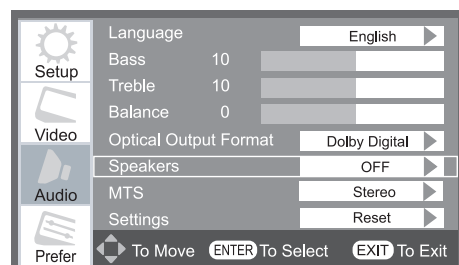

Reset Factory Defaults of Audio

To reset all tone quality of Audio to their factory default values:

- 1 Press **MENU** and open the **Audio** menu.
- 2 Highlight **Settings**.
- 3 Press **▶** or **ENTER**, all Audio settings will recover to factory default values.

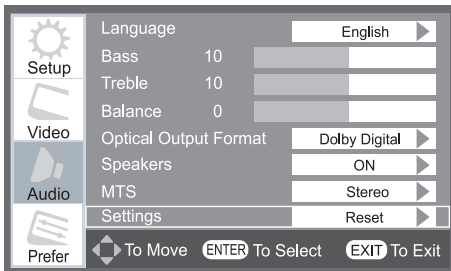

Selecting the optical output format

You can use this feature to select the optical output format when you connect a Dolby Digital decoder or other digital audio system to the **DIGITAL AUDIO OUT** terminal on the TV (see “Connecting a digital audio system” on page 18).

To select the optical output format:

- 1 Press **MENU** and open the **Audio** menu.
- 2 Highlight **Optical Output Format**.
- 3 Press **▶** or **ENTER** cyclically to select either **Dolby Digital** or **PCM**, depending on your device.

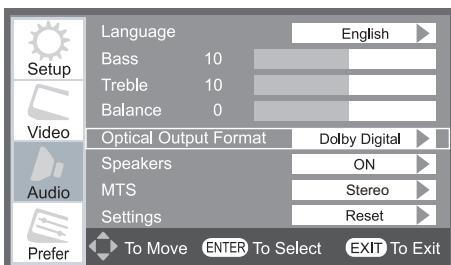

- 4 Press **EXIT** to save and quick system menu.

Using the Parental Control menu

The Parental Control menu includes US Ratings, Canadian Rating, Advanced Rating, Advanced Parental Lock and New PIN Code. You can use these features after entering the correct PIN code.

Entering the PIN code

- 1 Press **MENU** and open the **Prefer** menu.
- 2 Highlight **Parental Control**.

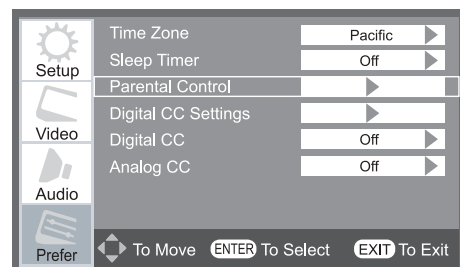

- 3 Press **▶** or **ENTER** to displays the PIN code entry screen. Using the numeric key to key in password. (Default password is 0000)

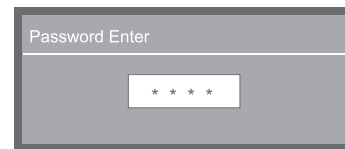

- If the wrong PIN code is entered, the message “Password Error,Retry:” appears. Enter the code again.

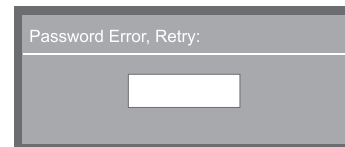

- When the correct PIN code is entered, the **Parental Control Menu** opens.

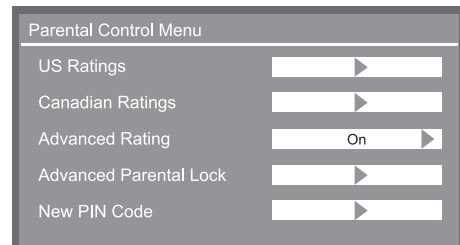

Changing your PIN code

There is available to change PIN code.

- 1 Press correct PIN code as above to open the **Parental Control Menu**.
- 2 Highlight **New PIN Code**.

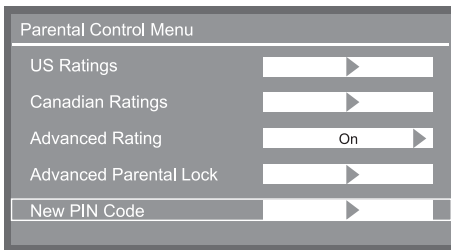

- 3 Press **▶** or **ENTER**, A new menu icon will displays as below.

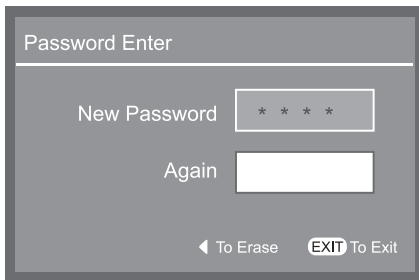

- 4 Using the numeric key to press the New Password of four-digit PIN code, then key in new password again to confirm. A successful message will appear.



If you still cannot remember your PIN code

While the PIN code entering screen is displayed, press **RECALL** four times within five seconds. The PIN code will be cleared and you can enter a new PIN code.

Blocking TV programs and movies by rating (V-Chip)

Some TV programs and movies include signals that classify the content of the program (violence, sex, dialog, language). The V-Chip feature in this TV detects the signals and blocks the programs according to the ratings you select. (For rating descriptions, see the tables on the next page).

To block and unblock TV programs and movies:

- 1 Press correct PIN code as above to open the **Parental Control Menu**.
- 2 Press **▲▼** buttons to highlight **US Ratings**.
- 3 Press **▶** or **ENTER**, A new menu icon "Parental Control Menu" will appear.
- 4 Press **▲▼◀▶** buttons and **ENTER** to select the level of blocking you prefer. A box with an "🔒" is a rating that will be blocked.

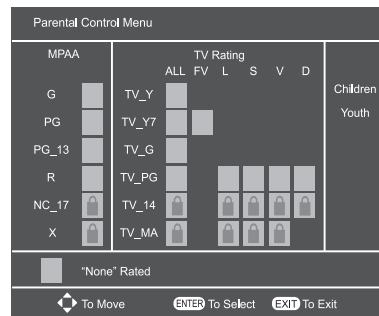

* If you place an "🔒" in the box "None" Rated, program rated "None" will be blocked; however, programs that do not provide any rating information will not be blocked.

**Right side are two default blocked setting that named "Children" & "Youth" for you to choose directly, the default rating as below.

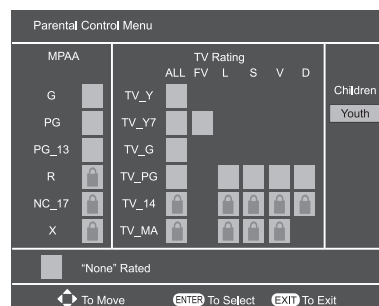
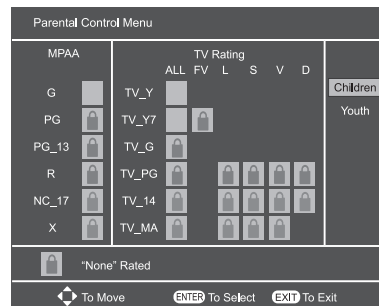

Independent rating system for broadcasters	
Ratings	Description and Content themes
TV-MA	Mature Audience Only (This program is specifically designed to be viewed by adults and therefore may be unsuitable for children under 17.) L) Crude or indecent language S) Explicit sexual activity V) Graphic violence
TV-14	Parents Strongly Cautioned (This program contains some material that many parents would find unsuitable for children under 14 years of age.) D) Intensely suggestive dialog L) Strong, coarse language S) Intense sexual situations V) Intense violence
TV-PG	Parental Guidance Suggested (This program contains material parents may find unsuitable for younger children.) D) Some suggestive dialog L) Infrequent coarse language S) Some sexual situations V) Moderate violence
TV-G	General Audience (Most parents would find this program suitable for all ages.)
TV-Y7	Directed to Older Children (This program is designed for children age 7 and above.)
TV-Y	All Children (This program is designed to be appropriate for all children.)

Independent rating system for movies	
Ratings	Description and Content themes
X	X-rated (For adults only)
NC-17	Not intended for anyone 17 and under
R	Restricted (Under 17 requires accompanying parent or adult)
PG-13	Parents Strongly Cautioned (Some material may be inappropriate for children under 13)
PG	Parental Guidance Suggested (Some material may not be suitable for children)
G	General Audience (Appropriate for all ages)

Note:

- "Canadian Ratings" is for Canada area (if available), operation is same as "US Ratings".
- If "RRT5" is available on your program provider. You can set "Advanced Rating" to On, and get a item "Advanced Parental Lock". Press **▶** or **ENTER**, a new menu icon will appear and you can follow menu instruction to set up ratings.

Using the PC settings feature

You can view an image from a PC on the TV screen. When a PC is connected to the TV's PC IN terminal, you can use the PC Settings feature to make adjustments to the image. If the edges of the picture are cut off, readjust the **H-Position** and **V-Position**. If the picture is affected by interference, readjust the **Clock** and **Phase**.

To adjust the PC settings:

- 1 Repeatedly press **INPUT** to select PC input mode (see "Selecting the video input source to view" page 32).
- 2 Press **MENU** and open the **Prefer** menu.
- 3 Highlight **PC Settings** menu.

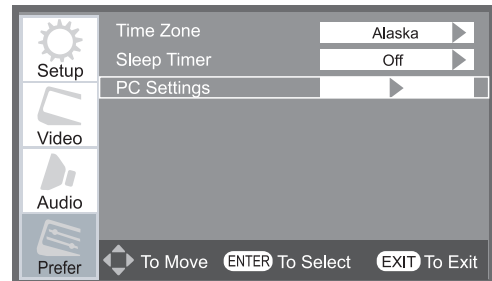

Note: If a PC is not connected or there is no pc input signal, this feature will be grayed out in the **Prefer** menu.

- 4 Press **▶** or **ENTER**, a new set of **PC Settings** menu icon will displays as below.
- 5 Press **▲** or **▼** to highlight the item you want to adjust.

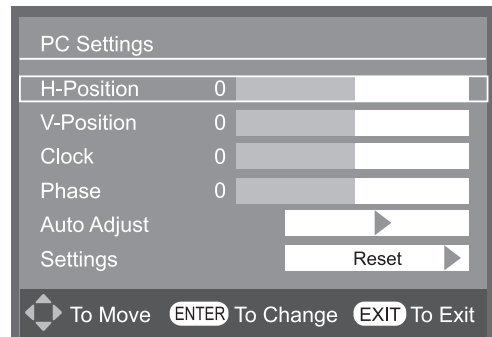

- 6 Press **ENTER**, a new adjustment bar will appear as below. Press **◀** or **▶** to make the appropriate adjustments.



Note: The screen is disrupted momentarily when adjusting the PC settings. This is not a sign of malfunction.

To execute "Auto Adjust" is recommend when you input a PC timing every time. The image will be auto adjusting by system internally to get an optimum H/V-Position, Clock and Phase.

- **H-Position:**
Moves the picture left/right.
The adjustment range is -50~+50 (default value is 0).*
- **V-Position:**
Moves the picture up/down.
The adjustment range is -10~+10 (default value is 0).*
- **Clock:**
Helps to reduce noise and sharpen the picture.
The adjustment range is -10~+10 (default value is 0).*
- **Phase:**
Helps to reduce noise and minimize periodic vertical stripes on the screen.
The adjustment range is -15~+16 (default value is 0).*

* The default settings may vary depending on the input signal format.

Setting the PC Audio

If the INPUT source is set to PC. The PC IN audio phone jack is applied for PC IN when PC IN terminal is connecting with an analog RGB cable. (☞ page 18)

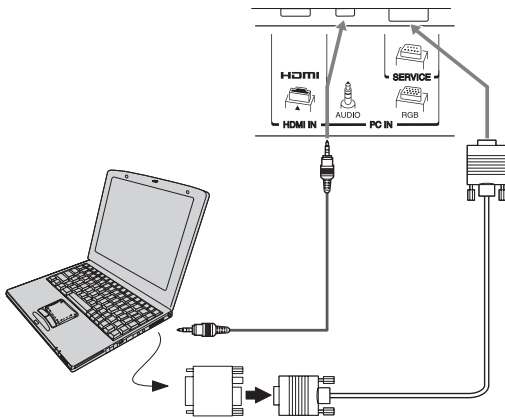

Note: Because the PC Audio input is shared with HDMI. If INPUT source is set to "HDMI," And the HDMI signal is DVI format. This PC Audio input will apply for HDMI. (Also see item 2 on page 11.)

Setting the sleep timer

You can set the sleep timer to turn off the TV after a set length of time (maximum of 90 minutes).

To set the sleep timer using the remote control:

Press **SLEEP** on the remote control to set the length of time until the TV turns off. Repeatedly press **SLEEP** to increase the time in 30-minute increments, to a maximum of 90 minutes.

To set the sleep timer using the on-screen menus:

- 1 Press **MENU** and open the **Prefer** menu.
- 2 Highlight **Sleep Timer**.
- 3 Press **▶** or **ENTER** to increase the time in 30-minute increments.

Off→30 Min→60 Min→90 Min→Off

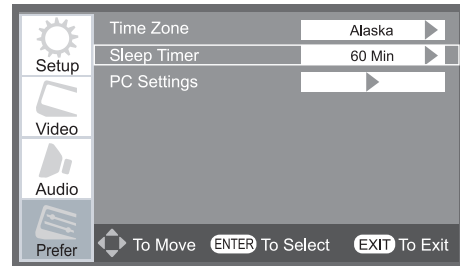

Note: When a power failure occurs, the sleep timer setting may be cleared.

To display the remaining sleep timer:

Press **SLEEP** on the remote control or same as above process using the on-screen menus.

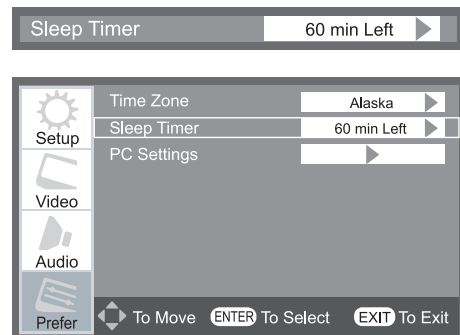

To cancel the sleep timer:

Repeatedly press **SLEEP** until it is set to Off.

Setting the time zone

To set the time zone:

- 1 Press **MENU** and open the **Prefer** menu.
- 2 Highlight **Time Zone**.
- 3 Press **▶** or **ENTER** to select Pacific, Alaska, Hawaii, Eastern, Central and Mountain.

Pacific→Alaska→Hawaii→Eastern→Central→
Mountain→Pacific

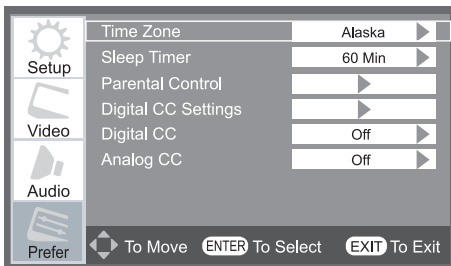

Note: After you change the Time Zone setting, when you press **INFO**, you will see that the program duration has been changed. For more details on **INFO**, see "To display TV status information using **INFO**" section on this page.

Displaying TV status information

To display TV status information using **RECALL**:

Press **RECALL** on the remote control.

The following information will display (if applicable):

- Current input (**ANT**, **Video**, etc.)
- Channel number (if in **ANT** mode)
- Channel label (if set)
- Digital signal strength indicator (bar graph in top right corner of box)
- Stereo or SAP audio status
- Video resolution
- Aspect ratio of incoming video signal (4:3 or 16:9)
- V-Chip rating status

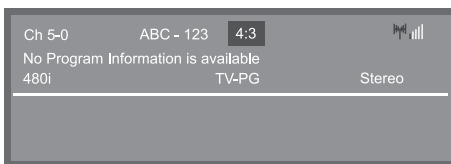

To close the **RECALL** screen:

Press **EXIT** on the remote control.

To display TV status information using **INFO**:

Press **INFO** on the remote control.

The following additional information will display for off air digital channels (if applicable):

- Title
- Duration
- Detailed description

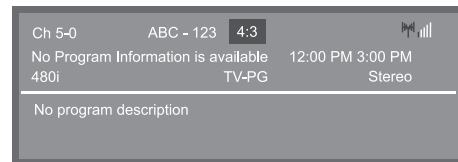

To close the **Information** screen:

Press **EXIT** on the remote control.

Understanding the auto power off feature

The TV will automatically turn itself off after approximately 15 minutes if it is tuned to a vacant channel or a station that completes its broadcast for the day. This feature functions in **ANT** mode only.

Understanding the last mode memory feature

If the power is cut off while you are viewing the TV, the Last Mode Memory feature automatically turns on the TV when the power is resupplied.

Note: You should unplug the TV's power cord if it is possible that you will be away from the TV for an extended period of time after the power is restored.

Chapter 7: Using the TV's advanced features

Using the advanced picture settings features

Using Dynamic Contrast

When dynamic contrast is set to **ON**, the TV will detect changes in the picture quality that affect the appearance of your contrast settings and then automatically adjust the video.

To select dynamic contrast preferences:

- 1 Press **MENU** and open the **Video** menu.
- 2 Highlight **Advanced Picture** and press **▶** or **ENTER**.

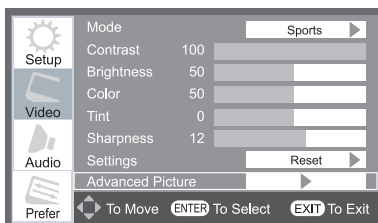

- 3 Highlight **Dynamic Contrast** item, and press **▶** or **ENTER** to select On or Off.

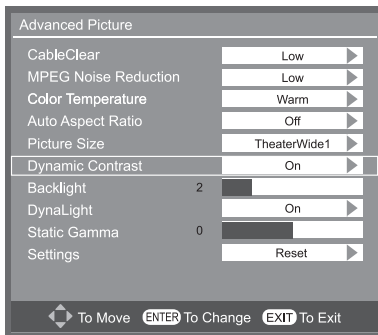

Using DynaLight™

When DynaLight™ is set to **ON**, the TV will detect changes in the picture quality that affect the appearance of your backlight settings and then automatically adjust the video.

To select DynaLight:

- 1 Press **MENU** and open the **Video** menu.
- 2 Highlight **Advanced Picture** and press **▶** or **ENTER**.
- 3 Highlight **DynaLight** and press **▶** or **ENTER** to select On or Off.

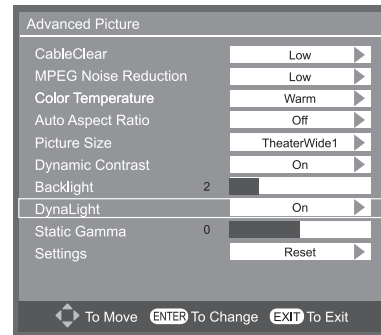

Backlight Adjustment

There is a function to let you to adjust the Backlight.

To select Backlight adjustment:

- 1 Press **MENU** and open the **Video** menu.
- 2 Highlight **Advanced Picture** and press **▶** or **ENTER**.
- 3 Highlight **Backlight** and press **ENTER**, a new adjustment bar will appear as below.
- 4 Press **◀** or **▶** to adjust the setting value.
- 5 Press **ENTER** to save and back to previous menu icon, or press **EXIT** to save and quit system menu.

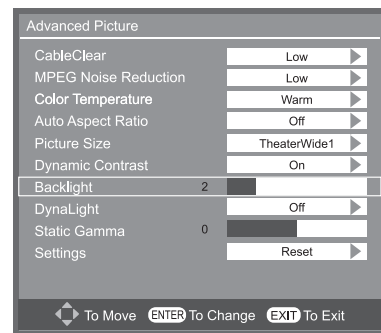

Note: If you want to adjust the **Backlight** item, the **DynaLight** item should be set to **Off**, otherwise the **Backlight** item will be grayed out in the **Advanced Picture** menu.

Using the static gamma feature

The static gamma feature allows you to adjust the levels of black in the picture.

To adjust the static gamma settings:

- 1 Press **MENU** and open the **Video** menu.
- 2 Highlight **Advanced Picture** and press **▶** or **(ENTER)**.
- 3 Highlight **Static Gamma** and press **(ENTER)**, a new adjustment bar will appear as below.

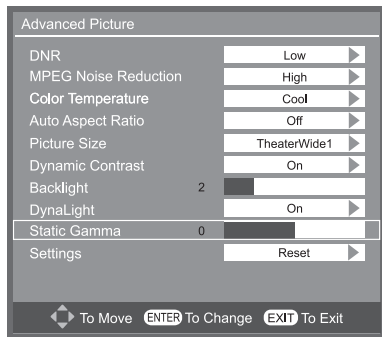

- 4 In the **Static Gamma** field, press **◀** or **▶** to adjust the static gamma.
The adjustment range is within ± 5 from center.



- If the setting is moved in the minus direction, the detail of black colors will be decreased.
- If the setting is moved in the plus direction, the detail of black colors will be increased.

Note: If you select one of the factory-set picture modes (**Sports**, **Standard** or **Movie**) and then change the static gamma setting, the picture mode automatically changes to **Preference**.

Using the auto aspect ratio feature

When the auto aspect ratio feature is set to **On**, the TV will automatically select the picture size when one of the following input sources is received:

- A 480i signal from the **VIDEO** input.
- A 480i, 480p, 720p, 1080i signal from the **HDMI** input.

Aspect ratio of signal source	Automatic aspect size (automatically selected when Auto Aspect is On)
4:3 normal	Natural (with sidebars)
16:9 full	Full
Not defined (no ID-1 data or HDMI aspect data)	The current picture size you set under "Selecting the picture size" on page 33.

Note: The auto aspect ratio feature is not applicable to antenna or cable input sources.

To turn on the auto aspect ratio feature:

- 1 Press **MENU** and open the **Video** menu.
- 2 Highlight **Advanced Picture** and press **▶** or **(ENTER)**.
- 3 Highlight **Auto Aspect Ratio** and press **▶** or **(ENTER)** to select **On** or **Off**.

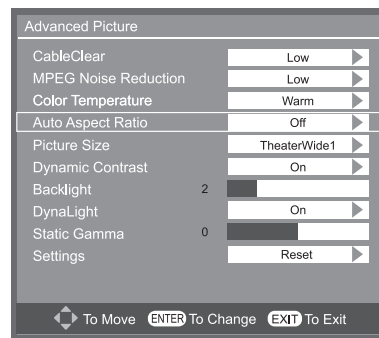

To turn off the auto aspect ratio feature:

Select **Off** in step 3 above.

Selecting the color temperature

You can change the quality of the picture by selecting from three preset color temperatures (Cool, Medium, and Warm), as described below.

Mode	Picture Quality
Cool	blueish
Medium	neutral
Warm	reddish

To select the color temperature:

- 1 Press **MENU** and open the **Video** menu.
- 2 Highlight **Advanced Picture** and press **▶** or **ENTER**.
- 3 Highlight **Color Temperature** and press **▶** or **ENTER** cyclically to select the mode you prefer (**Cool, Medium, or Warm**).

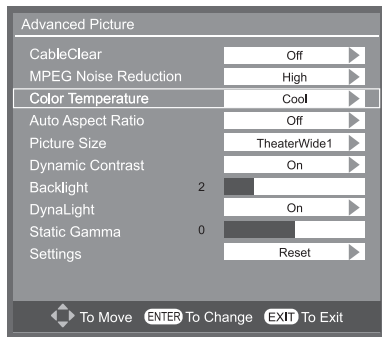

Using MPEG Noise Reduction

The MPEG noise reduction feature allows you to reduce visible interference caused by MPEG compression. Choices for MPEG noise reduction are **Off, Low, Middle, and High**.

To select the MPEG Noise Reduction level:

- 1 Press **MENU** and open the **Video** menu.
- 2 Highlight **Advanced Picture** and press **▶** or **ENTER**.
- 3 Highlight **MPEG Noise Reduction** and press **▶** or **ENTER** cyclically to select the mode you prefer (**Off, Low, Middle and High**)

Off→Low→Middle→High→Off

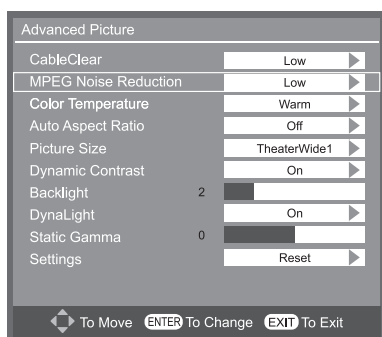

Using CableClear® digital noise reduction

The CableClear® digital noise reduction feature allows you to reduce visible interference in your TV picture. This may be useful when receiving a broadcast with a weak signal (especially a Cable channel) or playing a noisy video cassette or disc.

To change the CableClear settings:

- 1 Press **MENU** and open the **Video** menu.
- 2 Highlight **Advanced Picture** and press **▶** or **ENTER**.
- 3 Highlight **CableClear** and press **▶** or **ENTER**, cyclically to select the mode you prefer (**Off, Low, Middle and High**)

Off→Low→Middle→High→Off

Note:

- If the current input is **ANT, VIDEO**, the menu will display the text "CableClear." The available selections are **Off, Low, Middle, and High**.
- If the current input is **ColorStream HD, HDMI**, the menu will display the text "DNR." The available selections are **Off, Low, Middle, and High**. The **Low, Middle, and High** will reduce the noise in varying degrees, from lowest to highest, respectively.

* The HDMI input can accept and display DVI signal formats: (VGA, SVGA, XGA, WXGA) and Video signal formats: [480i (60Hz), 480p (60Hz), 720p (60Hz), 1080i (60Hz)]. But if the input signal is in DVI signal format, the DNR feature will be grayed out in the **Advanced Picture Menu**. For detailed signal specifications, see page 49.

For **ANT, VIDEO**

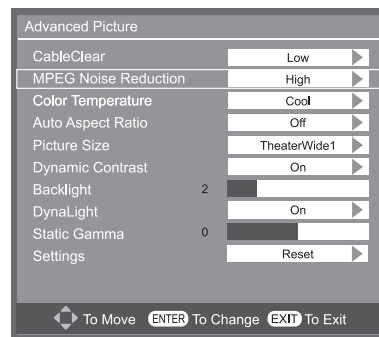

For **ColorStream HD, HDMI**.

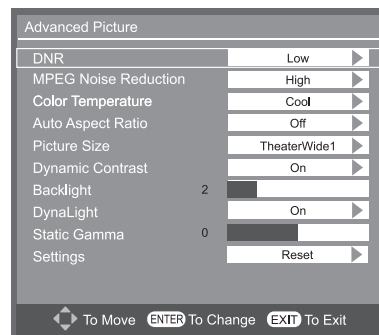

Chapter 8: Troubleshooting

General troubleshooting

Before calling a service technician, please check this chapter for a possible cause of the problem and some solutions you can try.

Black box on-screen

- The closed caption feature is set to one of the Text modes (**T1**, **T2**, **T3**, or **T4**). Set the closed caption feature to **Off** (see page 35,36).

Other problems

- If your TV's problem is not addressed in this Troubleshooting section or the recommended solution has not worked, please unplug the AC power cord at least 5 second then plug power cord again to restart the TV.

TV will not turn on

- Make sure the power cord is plugged in, and then press **POWER**.
- The remote control batteries may be dead. Replace the batteries or try the control panel buttons.

Picture problems

General picture problems

- Check the antenna/cable connections (see Chapter 2).
- Press **(INPUT)** on the remote control or TV and select a valid video input source (see page 32). If no device is connected to a particular input on the TV, no picture will display when you select that particular input source. For device connection details (see Chapter 2).
- Antenna reception may be poor. Use a highly directional outdoor antenna (if applicable).
- The station may have broadcast difficulties. Try another channel.
- Adjust the picture qualities (see page 35).
- If you are using a VCR, make sure **TV/VCR** on the remote control is set correctly (see page 22).
- Do not connect both a standard video cable and an S-video cable to the **VIDEO** input at the same time.

Noisy picture

- If you are watching an analog channel (off-air broadcast or Cable TV), you can set the **CableClear**® feature to reduce visible interference in the TV picture (see page 45).

Video Input Selection problems

- If the **Source List** window does not appear when you press **(INPUT)** on the remote control or TV, press **(INPUT)** a second time, which will change to the next video input source and display the **Source List** window.

Poor color or no color

- The station may have broadcast difficulties. Try another channel.
- Adjust the **Tint** and/or **Color** (see page 35).

Poor composite or S-video picture

- If the TV is connected to an external A/V device (e.g., DVD player, video game system, set-top box, etc.) try using a **ColorStream** or **HDMI** video connection instead.

Picture and sound are out of sync

- As with all products that contain a digital display, in rare instances, when viewing certain content (e.g., television broadcasts, video games, DVDs), you may notice that the sound and picture are slightly out of sync. This phenomenon can be caused by various factors including, without limitation, video processing within the TV, video processing in an attached gaming system, and video processing or different compression rates used by broadcasters in their programming. You may want to try one or more of the following suggestions, which may help to reduce the effect of this phenomenon:
 - If the TV is connected to an A/V receiver that has a programmable audio delay feature, use this feature to help synchronize the sound to the picture.
 - If you notice this phenomenon only on certain TV channels, please contact your local broadcast, cable, or satellite provider to inform them of this issue.

Sound problems

- Check the antenna/cable connections (see Chapter 2).
- The station may have broadcast difficulties. Try another channel.
- The sound may be muted. Press **VOL+** and **VOL-**.
- If you hear no sound, try setting the **MTS** feature to **Stereo** mode (see page 36,37).
- If you are not receiving a second audio program from a known SAP source, make sure the **MTS** feature is set to **SAP** mode (see page 36,37).
- If you hear audio that seems "incorrect" for the program you are watching (such as music or a foreign language), the SAP mode may be on. Set the **MTS** feature to **Stereo** mode (see page 36,37).

Remote control problems

- Make sure the remote control is set to the correct device mode (see page 21).
- Remove all obstructions between the remote control and the TV.
- The remote control batteries may be dead. Replace the batteries (see page 20).
- Your TV remote control may not operate certain features on your external device. Refer to the owner's manual for your other device to determine its available features. If your TV remote control does not operate a specific feature on another device, use the remote control that came with the device (see pages 22–26).

Channel tuning problems

- Make sure the remote control is set to the correct device mode (see page 21).
- The channel may be setting to **"Not Viewable"** by the **Manual Ch Set** feature. Please set **"Viewable"** to unblock the channel (see page 31).
- If you are unable to tune digital channels, check the antenna configuration (see page 29). If you are still unable to tune digital channels, clear all channels from the channel list (see page 31) and reprogram channels into the channel memory (see page 30).

Closed caption problems

- If the program or video you selected is not closed-captioned, no captions will display (see page 35,36).
- If text is not available, a black rectangle may appear. If this happens, turn off the closed caption feature (see page 35,36).
- A closed-caption signal may not display correctly in the following situations: a) when a videotape has been dubbed; b) when the signal reception is weak; or c) when the signal reception is nonstandard (see page 35,36).

Rating blocking (V-Chip) problems

- If you forget your PIN code: Press **RECALL** four times within five seconds. The PIN code will be cleared and you can enter a new PIN code.
- The V-Chip feature is available for the U.S. V-Chip system, or Canada (if available) (see page 39,40).

HDMI problems

For HDMI cables

- Make sure to use cables with the HDMI Logo (**HDMI**) (see page 17).

For Legacy HDMI source

- Some legacy HDMI sources may not work properly with the latest HDMI TV products, due to new standard adoption.

LED indications

The green or red LED lights on the TV front indicate the TV's status, as described below.

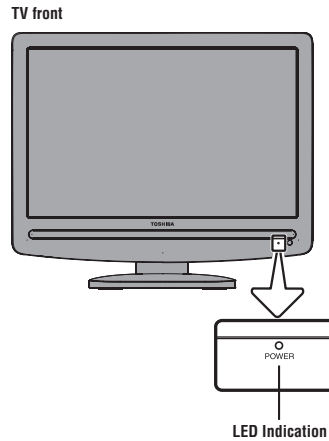

LED Indication	Condition
1) Green	The TV is operating properly.
2) Red	Power off (standby mode)

If the problem still exists:

- In the U.S., call TACP Consumer Solutions at 1-800-575-5469.
- In Canada, locate the nearest Toshiba authorized service depot by directing your web browser to www.toshiba.ca; click “Home Entertainment,” and then click “Support.”

Specifications

Note:

- *This model complies with the specifications listed below.*
- *Designs and specifications are subject to change without notice.*
- *This model may not be compatible with features and/or specifications that may be added in the future.*

Television System

NTSC standard
ATSC standard (8VSB)
Digital Cable (64 QAM, 256 QAM; in-the-clear, unencrypted)

Channel Coverage

VHF: 2 through 13
UHF: 14 through 69
Cable TV: Mid band (A-8 through A-1, A through I)
Super band (J through W)
Hyper band (AA through ZZ, AAA, BBB)
Ultra band (65 through 94, 100 through 135)

Power Source: 120 V AC, 60 Hz

Power Maximum Current

19AV500U: 0.8 A
19AV501U: 0.8 A

Power Consumption

19AV500U: 0.5 W in standby mode
19AV501U: 0.5 W in standby mode

Audio Power: 3W+3W

Video/Audio Terminals

S-VIDEO INPUT:

Y: 1 V(p-p), 75 ohm, negative sync.
C: 0.286 V(p-p) (burst signal), 75 ohm

VIDEO/AUDIO INPUT:

VIDEO: 1 V(p-p), 75 ohm, negative sync.
AUDIO: 150 mV(rms) (30% modulation equivalent, 22 k ohm or greater)

ColorStream® (component video) HD INPUT:

VIDEO: Y: 1V(p-p), 75 ohm
PR: 0.7 V(p-p), 75 ohm
PB: 0.7 V(p-p), 75 ohm
Suggested formats: 1080i, 720p, 480p, 480i
AUDIO: 150 mV(rms), 22 k ohm or greater

HDMI™ INPUT:

HDMI compliant (type A connector)
HDCP compliant
Audio Lip Sync supported
Suggested formats: See table on the next page.
HDMI Audio: 2-channel Linear-PCM; 32/44.1/48 kHz sampling frequency; 16/20/24 bits per sample

DIGITAL AUDIO OUTPUT:

Optical type

PC INPUT:

15-Pin D-sub Analog RGB

Dimensions

19AV500U:

Width: 1'6-1/8 inches (460 mm)
Height: 1'3-7/16 inches (392.7 mm)
Depth: 8-3/16 inches (207.2 mm)

19AV501U:

Width: 1'6-1/8 inches (460 mm)
Height: 1'3-7/16 inches (392.7 mm)
Depth: 8-3/16 inches (207.2 mm)

Mass (Weight)

19AV500U: 14.9 lbs (6.7 kg)
19AV501U: 14.9 lbs (6.7 kg)

Operating conditions

Temperature: 32°F - 95°F (0°C - 35°C)
Humidity: 20 - 80% (no moisture condensation)

Supplied Accessories

- Remote control with two size “AAA” batteries
- Owner’s manual (this book)
- Cleaning cloth
- Power Cord

HDMI input supports the following signal formats:

Format	Resolution	V. Frequency	H. Frequency	Pixel Clock Frequency
VGA	640 × 480	59.940Hz	31.469kHz	25.175MHz
SVGA	800 × 600	60.320Hz	37.880kHz	40.000MHz
XGA	1024 × 768	60.000Hz	48.360kHz	65.000MHz
WXGA	1280 × 768	59.876Hz	47.776kHz	79.500MHz
WXGA	1360 × 768	60.015Hz	47.712kHz	85.500MHz
480i	720 × 480i	59.940Hz	15.730kHz	27.000MHz
480p	720 × 480p	59.940Hz	31.470kHz	27.000MHz
720p	1280 × 720p	60.000Hz	45.000kHz	74.250MHz
1080i	1920 × 1080i	60.000Hz	33.750kHz	74.250MHz

Limited United States Warranty for 19" LCD Televisions

Toshiba America Consumer Products, L.L.C. ("TACP") makes the following limited warranties to original consumers in the United States.

THESE LIMITED WARRANTIES EXTEND TO THE ORIGINAL CONSUMER PURCHASER OR ANY PERSON RECEIVING THIS LCD TELEVISION AS A GIFT FROM THE ORIGINAL CONSUMER PURCHASER AND TO NO OTHER PURCHASER OR TRANSFEREE. LCD TELEVISIONS PURCHASED IN THE U.S.A. AND USED ANYWHERE OUTSIDE OF THE U.S.A., INCLUDING, WITHOUT LIMITATION, CANADA AND MEXICO, ARE NOT COVERED BY THESE WARRANTIES. LCD TELEVISIONS PURCHASED ANYWHERE OUTSIDE OF THE U.S.A., INCLUDING, WITHOUT LIMITATION, CANADA AND MEXICO, AND USED IN THE U.S.A., ARE NOT COVERED BY THESE WARRANTIES.

Limited One (1) Year Warranty on Parts and Labor

TACP warrants this LCD Television and its parts against defects in materials or workmanship for a period of one (1) year after the date of original retail purchase. DURING THIS PERIOD, TACP WILL, AT TACP'S OPTION, REPAIR OR REPLACE A DEFECTIVE PART WITH A NEW OR REFURBISHED PART WITHOUT CHARGE TO YOU FOR PARTS OR LABOR. During this period, TACP Authorized Service Station personnel will come to your home when warranty service is required. Depending on the type of repair required, the service will either be performed in your home or the LCD Television will be taken to a TACP Authorized Service Station for repair and returned to your home at no cost to you.

Rental Units

The warranty for LCD Television rental units begins on the date of the first rental or thirty (30) days after the date of shipment to the rental firm, whichever comes first.

Limited Warranty for Commercial Units

TACP warrants LCD Televisions that are sold and used for commercial purposes as follows: all parts are warranted against defects in materials or workmanship for a period of ninety (90) days after the date of original retail purchase. DURING THIS PERIOD, TACP WILL, AT TACP'S OPTION, REPAIR OR REPLACE A DEFECTIVE PART WITH A NEW OR REFURBISHED PART WITHOUT CHARGE TO YOU.

Owner's Manual and Product Registration Card

Read this owner's manual thoroughly before operating this LCD Television.

Complete and mail the enclosed product registration card or register your LCD Television online at www.tacp.toshiba.com/service as soon as possible. By registering your LCD Television you will enable TACP to bring you new products specifically designed to meet your needs and help us to contact you in the unlikely event a safety notification is required under the U.S. Consumer Product Safety Act.

Failure to complete and return the product registration card does not diminish your warranty rights.

Your Responsibility

THE ABOVE WARRANTIES ARE SUBJECT TO THE FOLLOWING CONDITIONS:

- (1) You must retain your original bill of sale or provide other proof of purchase.
- (2) All warranty servicing of this LCD Television must be performed by an Authorized TACP Service Station.
- (3) The warranties from TACP are effective only if this LCD Television is purchased and operated in the Continental U.S.A. or Puerto Rico.
- (4) Labor service charges for set installation, setup, adjustment of customer controls, and installation or repair of antenna systems are not covered by this warranty. Reception problems caused

by inadequate antenna systems, misaligned satellite dishes, cable television distribution, VCRs, DVD players/recorders, personal computer level IEEE-1394 devices, and any other connected signal source device are your responsibility.

- (5) Warranties extend only to defects in materials or workmanship as limited above, and do not extend to any LCD Television or parts that have been lost or discarded by you or to damage to the LCD Television or parts caused by fires, misuse, accident, Acts of God (such as lightning or fluctuations in electric power), improper installation, improper maintenance, or use in violation of instructions furnished by TACP; use or malfunction through simultaneous use of this LCD Television and connected equipment; or to units that have been modified or had the serial number removed, altered, defaced, or rendered illegible.

How to Obtain Warranty Service

If, after following all of the operating instructions in this manual and reviewing the section entitled "Troubleshooting," you find that service is needed:

- (1) To find the nearest TACP Authorized Service Station, visit TACP's website at www.tacp.toshiba.com/service or contact TACP's Consumer Solution Center toll free at 1-800-575-5469.
- (2) You must present your original bill of sale or other proof of purchase to the TACP Authorized Service Station.

**For additional information, visit TACP's website:
www.tacp.toshiba.com**

ALL WARRANTIES IMPLIED BY THE LAW OF ANY STATE OF THE U.S.A., INCLUDING THE IMPLIED WARRANTIES OF MERCHANTABILITY AND FITNESS FOR A PARTICULAR PURPOSE, ARE EXPRESSLY LIMITED TO THE DURATION OF THE LIMITED WARRANTIES SET FORTH ABOVE. WITH THE EXCEPTION OF ANY WARRANTIES IMPLIED BY THE LAW OF ANY STATE OF THE U.S.A. AS HEREBY LIMITED, THE FOREGOING WARRANTY IS EXCLUSIVE AND IN LIEU OF ALL OTHER WARRANTIES, GUARANTEES, AGREEMENTS, AND SIMILAR OBLIGATIONS OF TACP WITH RESPECT TO THE REPAIR OR REPLACEMENT OF ANY PARTS. IN NO EVENT SHALL TACP BE LIABLE FOR CONSEQUENTIAL OR INCIDENTAL DAMAGES (INCLUDING, BUT NOT LIMITED TO, LOST PROFITS, BUSINESS INTERRUPTION, OR MODIFICATION OR ERASURE OF RECORDED DATA CAUSED BY USE, MISUSE OR INABILITY TO USE THIS LCD TELEVISION).

No person, agent, distributor, dealer, or company is authorized to change, modify, or extend the terms of these warranties in any manner whatsoever. The time within which an action must be commenced to enforce any obligation of TACP arising under the warranty or under any statute or law of the United States or any state thereof is hereby limited to ninety (90) days from the date you discover, or should have discovered, the defect. This limitation does not apply to implied warranties arising under the law of any state of the U.S.A.

THIS WARRANTY GIVES YOU SPECIFIC LEGAL RIGHTS AND YOU MAY ALSO HAVE OTHER RIGHTS WHICH MAY VARY FROM STATE TO STATE IN THE U.S.A. SOME STATES OF THE U.S.A. DO NOT ALLOW LIMITATIONS ON THE DURATION OF AN IMPLIED WARRANTY, WHEN AN ACTION MAY BE BROUGHT, OR THE EXCLUSION OR LIMITATION OF INCIDENTAL OR CONSEQUENTIAL DAMAGES. THEREFORE, THE ABOVE PROVISIONS MAY NOT APPLY TO YOU UNDER SUCH CIRCUMSTANCES.

Limited Canadian Warranty for Toshiba Brand Flat Panel Televisions

Toshiba of Canada Limited (“TCL”) makes the following limited warranties to original consumers in Canada. THESE LIMITED WARRANTIES EXTEND TO THE ORIGINAL CONSUMER PURCHASER OR ANY PERSON RECEIVING THIS TOSHIBA BRAND FLAT PANEL TELEVISION (the “TELEVISION(S)” or “Television(s)”) AS A GIFT FROM THE ORIGINAL CONSUMER PURCHASER AND TO NO OTHER PURCHASER OR TRANSFEREE.

TELEVISIONS PURCHASED IN CANADA, AND USED ANYWHERE OUTSIDE OF CANADA INCLUDING, WITHOUT LIMITATION, THE UNITED STATES AND MEXICO, ARE NOT COVERED BY THESE WARRANTIES.

TELEVISIONS PURCHASED ANYWHERE OUTSIDE OF CANADA, INCLUDING, WITHOUT LIMITATION, THE UNITED STATES AND MEXICO, AND USED IN CANADA, ARE NOT COVERED BY THESE WARRANTIES.

Limited One (1) Year Warranty on Parts and Labour

Subject to the more limited warranty if the Television is used for any commercial or business purposes as set out below, TCL warrants the Television and its parts against material defects in materials or workmanship that result in the Television failing for a period of one (1) year after the date of original retail purchase. DURING THIS PERIOD, TCL WILL, AT TCL'S OPTION, REPAIR OR REPLACE A DEFECTIVE PART WITH A NEW OR REFURBISHED PART WITHOUT CHARGE TO YOU FOR PARTS OR LABOUR.

- (a) FOR TELEVISIONS 32 INCHES OR LESS: YOU MUST DELIVER THE ENTIRE TELEVISION TO A TCL TELEVISION AUTHORIZED SERVICE PROVIDER (“ASP”). YOU MUST PAY FOR ALL TRANSPORTATION AND INSURANCE CHARGES FOR THE TELEVISION TO AND FROM THE ASP.
- (b) FOR TELEVISIONS OVER 32 INCHES: During this period, ASP personnel will come to your home when warranty service is required. Depending on the type of repair required, the service will either be performed in your home or the Television will be taken to an ASP for repair and returned to your home at no cost to you. IN-HOME SERVICE ONLY APPLIES WITHIN 100 KILOMETERS OF AN ASP. IF YOU ARE NOT WITHIN 100 KILOMETERS OF AN ASP, YOU MUST DELIVER THE ENTIRE TELEVISION TO AN ASP. YOU MUST PAY FOR ALL TRANSPORTATION AND INSURANCE CHARGES FOR THE TELEVISION TO AND FROM THE ASP.

Limited Warranty for Commercial Units

TCL warrants Televisions that are used for any commercial or business purposes as follows: all parts are warranted against material defects in materials or workmanship that result in the Television failing for a period of ninety (90) days after the date of original retail purchase. DURING THIS PERIOD, TCL WILL, AT TCL'S OPTION, REPAIR OR REPLACE THE DEFECTIVE PART WITH A NEW OR REFURBISHED PART WITHOUT CHARGE TO YOU.

- (c) FOR TELEVISIONS 32 INCHES OR LESS: YOU MUST DELIVER THE ENTIRE TELEVISION TO AN ASP. YOU MUST PAY FOR ALL TRANSPORTATION AND INSURANCE CHARGES FOR THE TELEVISION TO AND FROM THE ASP.

- (d) FOR TELEVISIONS OVER 32 INCHES: During this period, ASP personnel will come on-site when warranty service is required. Depending on the type of repair required, the service will either be performed on-site or the Television will be taken to an ASP for repair and returned at no cost to you. **ON-SITE SERVICE ONLY APPLIES WITHIN 100 KILOMETERS OF AN ASP. IF YOU ARE NOT WITHIN 100 KILOMETERS OF AN ASP, YOU MUST DELIVER THE ENTIRE TELEVISION TO AN ASP. YOU MUST PAY FOR ALL TRANSPORTATION AND INSURANCE CHARGES FOR THE TELEVISION TO AND FROM THE ASP.**

Rental Units

The warranty for Television rental units begins with the date of first rental or thirty (30) days from the date of shipment to the rental firm, whichever comes first.

Your Responsibility

THE ABOVE WARRANTIES ARE SUBJECT TO THE FOLLOWING CONDITIONS:

- (1) You must provide your bill of sale or other proof of purchase.
- (2) All warranty servicing of this Television must be performed by an ASP.
- (3) The warranties from TCL are effective only if the Television is (i) purchased as new and unopened from TCL or from TCL's authorized distributors, dealers or resellers (“ADR's”) and (ii) located/operated in Canada.
- (4) Labour charges for set installation, setup, adjustment of customer controls, and installation or repair of antenna systems are not covered by these warranties. Reception problems caused by inadequate antenna systems are your responsibility.
- (5) Warranties extend only to material defects in materials or workmanship as limited above, and do not extend to:
 - a. Service, repairs or replacement made necessary by accident, misuse, abuse, moisture, liquids, dust, dirt, neglect, accident, damage, 24/7 applications, improper installation, improper operation, improper cleaning, improper maintenance, normal wear and tear, screen burn or image retention caused by prolonged display of static images and/or phosphor aging, or any other external cause or event, act or omission outside the control of TCL, including fire, theft, acts of God, alteration, power failures, power surges or power shortages, lightning, other electrical faults, or repairs, modifications or replacements by persons other than those authorized by TCL to service the Television;
 - b. Replacement of missing, discarded or lost parts, the provision of retrofits, or preventive maintenance;
 - c. Repair of damage that is cosmetic only or does not affect the Television functionality, such as wear and tear, scratches and dents;
 - d. Service on Toshiba-branded accessory items (such accessory items may be covered by their own warranty);
 - e. Service on third party products or service made necessary by use of incompatible third party products;
 - f. Service made necessary by the simultaneous use of this Television and connected equipment;
 - g. Modifications to the Television not approved in writing by TCL, and service made necessary by the use or installation of non-Toshiba modifications to the Television;
 - h. Service of a Television on which the TOSHIBA label or logo, rating label or serial number have been defaced or removed;
 - i. On-site service and repair of the Television; and
 - j. Damage to the Television caused by failure to follow the specifications, User manuals or guides as to usage and/or storage.

Disclaimer and Limitation of Remedy

TO THE EXTENT NOT PRECLUDED BY LAW, ALL OTHER EXPRESS AND IMPLIED WARRANTIES, CONDITIONS AND REPRESENTATIONS FOR THIS TELEVISION, INCLUDING THE IMPLIED WARRANTIES, CONDITIONS AND REPRESENTATIONS OF MERCHANTABILITY AND FITNESS FOR A PARTICULAR PURPOSE, ARE HEREBY DISCLAIMED AND EXCLUDED. IF THE APPLICABLE LAW, STATUTORY OR OTHERWISE, PRECLUDES THE EXCLUSION OF ANY IMPLIED WARRANTIES, CONDITIONS AND REPRESENTATIONS THEN SUCH IMPLIED WARRANTIES, CONDITIONS AND REPRESENTATIONS ARE OTHERWISE LIMITED IN DURATION TO THE TERM OF THIS EXPRESS WRITTEN LIMITED WARRANTY. TO THE EXTENT NOT PRECLUDED BY LAW, STATUTORY OR OTHERWISE, THIS WRITTEN WARRANTY SUPERCEDES AND SPECIFICALLY DISCLAIMS ANY OTHER WARRANTY, CONDITION OR REPRESENTATION NOT STATED IN THIS WARRANTY, WHETHER MADE BY TCL, TOSHIBA CORPORATION, THEIR AFFILIATES, ADRs AND ASPs AND WHETHER MADE ORALLY OR IN WRITING (INCLUDING ANY STATEMENT IN ANY BROCHURE, PRESS RELEASE, ANNOUNCEMENT, ADVERTISEMENT, POINT OF SALE DISPLAY, ETC.).

YOU MUST READ AND FOLLOW ALL SET-UP AND USAGE INSTRUCTIONS IN THE APPLICABLE USER GUIDES AND/OR MANUALS. IF YOU FAIL TO DO SO, THIS TELEVISION MAY NOT FUNCTION PROPERLY AND YOU MAY SUFFER DAMAGE. THIS WARRANTY WILL NOT COVER ANY SERVICE THAT IS REQUIRED, IN PART OR IN WHOLE, AS A RESULT OF ANY FAILURE TO FOLLOW THE SET-UP AND USAGE INSTRUCTIONS. THIS WARRANTY DOES NOT APPLY AND SHALL BE VOID AND UNENFORCEABLE IF THE TELEVISION IS OPENED, SERVICED, OR REPAIRED BY PERSONS OTHER THAN THOSE AUTHORIZED BY TCL TO SERVICE OR REPAIR THE TELEVISION.

IF THE TELEVISION FAILS TO WORK AS WARRANTED ABOVE, YOUR SOLE AND EXCLUSIVE REMEDY SHALL BE REPAIR OR REPLACEMENT OF THE DEFECTIVE PART. IN NO EVENT WILL TCL, TOSHIBA CORPORATION, THEIR AFFILIATES, ADRs OR ASPs (THE "RELATED PARTIES") BE LIABLE TO YOU OR ANY THIRD PARTY FOR ANY DAMAGES, MONEY, REIMBURSEMENT, COSTS OR EXPENSES. THIS LIMITATION APPLIES TO DAMAGES, MONEY, REIMBURSEMENT, COSTS OR EXPENSES OF ANY KIND WHATSOEVER INCLUDING ANY DIRECT OR INDIRECT DAMAGES, DAMAGE TO PROPERTY OR PERSON, LOST PROFITS, LOST SAVINGS, INCONVENIENCE OR OTHER SPECIAL, INCIDENTAL, EXEMPLARY OR CONSEQUENTIAL DAMAGES, WHETHER FOR BREACH OF WARRANTY, BREACH OF CONTRACT, TORT (INCLUDING NEGLIGENCE), UNDER A STATUTE OR UNDER ANY OTHER LAW OR FORM OF ACTION, OR WHETHER ARISING OUT OF THE USE OF OR INABILITY TO USE THE TELEVISION, EVEN IF ANY OF THE RELATED PARTIES HAS BEEN ADVISED OF THE POSSIBILITY OF SUCH DAMAGES OR OF ANY CLAIM BY ANY OTHER PARTY.

No person, agent, distributor, dealer or company is authorized to change, modify or extend the terms of these warranties in any manner whatsoever.

Arbitration and Dispute Resolution

To the extent not precluded by law, any claim, dispute, controversy or disagreement (whether for breach of warranty, breach of contract, tort (including negligence), under a statute or under any other law or form of action) against any of the Related Parties arising out of, or otherwise relating to: (i) this warranty; (ii) the Television; (iii) any oral or written representations, statements, brochures, press releases, advertising, announcement, point of sale display, or promotional material relating to the Television; (iv) the relationships that result from this warranty, (the foregoing claims, disputes controversies and disagreements are collectively referred to as the "Dispute"), shall be referred to and resolved by final and binding arbitration (to the exclusion of the courts). To the extent not precluded by law, you agree to waive any right that you may have to commence or participate in any representative

or class proceeding against the Related Parties relating to any Dispute. If and where applicable and to the extent not precluded by law, you further agree to opt out of any such representative or class proceedings. Arbitration of any Dispute will be conducted in the forum and in the manner as agreed to between you and TCL. Failing such agreement, the arbitration will be conducted by one arbitrator pursuant to the laws and rules relating to arbitration generally in force in the jurisdiction in which you reside at the time that the Dispute arises. To the extent not precluded by law, no claim, dispute, controversy or disagreement of any other person may be joined or combined with any Dispute by you, without the prior written consent of TCL.

Critical Applications

The Television you have purchased is not designed for any "critical applications." "Critical applications" means life support systems, medical applications, connections to implanted medical devices, commercial transportation, nuclear facilities or systems or any other applications where Television failure could lead to injury to persons or loss of life or catastrophic property damage.

IF THE CUSTOMER USES THE TELEVISION IN ANY CRITICAL APPLICATION, THE CUSTOMER - AND NOT TCL, ITS AFFILIATES, ADRs OR ASPs - ASSUME SOLE AND FULL RESPONSIBILITY FOR SUCH USE. TCL RESERVES THE RIGHT TO REFUSE TO SERVICE ANY TELEVISION USED IN A CRITICAL APPLICATION. TCL, ITS AFFILIATES, ADRs AND ASPs HEREBY DISCLAIM ANY AND ALL LIABILITY, DAMAGES AND CONSEQUENCES ARISING OUT OF THE SERVICE OR REFUSAL TO SERVICE SUCH TELEVISION AND FURTHER DISCLAIM ANY AND ALL LIABILITY, CONSEQUENCES AND DAMAGES THAT MAY ARISE OR RESULT FROM THE USE OF THE TELEVISION IN ANY CRITICAL APPLICATIONS.

General Provisions

If and to the extent that any provision of this limited warranty should generally be found to be unenforceable, the unenforceable provision shall be severed from the warranty and deemed not to form part of the warranty. The remaining provisions of this warranty shall be and remain valid and enforceable. If and to the extent that any provision of this limited warranty as it relates to any of the Related Parties is found to be invalid or unenforceable in respect of that party (the "Excluded Party"), the Excluded Party shall be deemed to be severed or excluded from the provision, and the provision shall remain valid, enforceable and applicable in respect of the other or remaining Related Parties.

To the extent permitted by law, this limited warranty shall be governed and construed in accordance with the laws of Ontario.

If there is any inconsistency between this limited warranty, on the one hand, and any statement in the packaging of the Television or in any other document enclosed with, or used in the context of the promotion or sale of, the Television, on the other hand, the provisions of this limited warranty shall prevail.

How to Obtain Warranty Services

If, after following all of the operating instructions in this manual and checking the "Troubleshooting" section, you find that service is needed:

- (1) To find the nearest ASP, visit TCL's web site at www.toshiba.ca, or call toll free 1-800-268-3404
- (2) Present your bill of sale or other proof of purchase to the ASP.

For additional information, visit TCL's website at www.toshiba.ca

Notes

TOSHIBA AMERICA CONSUMER PRODUCTS, L.L.C.

Corporate Headquarters: 82 TOTOWA ROAD, WAYNE, NJ 07470, U.S.A.

NATIONAL SERVICE DIVISION: 1420-B TOSHIBA DRIVE, LEBANON, TN 37087, U.S.A.

TOSHIBA OF CANADA LTD.

HEAD OFFICE: 191 McNABB STREET, MARKHAM, ONTARIO, L3R 8H2, CANADA – TEL: (905) 470-5400

SERVICE CENTERS:

TORONTO: 191 McNABB STREET, MARKHAM, ONTARIO L3R 8H2, CANADA – TEL: (905) 470-5400

MONTREAL: 18050 TRANS CANADA, KIRKLAND, QUEBEC, H9J 4A1, CANADA – TEL: (514) 390-7766

VANCOUVER: 13551 COMMERCE PARKWAY, SUITE 110, RICHMOND, B.C., V6V 2L1, CANADA – TEL: (604) 303-2500

CableClear, ColorStream, and TheaterWide are registered trademarks of Toshiba America Consumer Products, L.L.C.

Channel Browser and DynaLight are trademarks of Toshiba America Consumer Products, L.L.C.

PRINTED IN CHINA
(HDA51V1900I)

TOSHIBA